



ET Manager Series

Installation and Operation Manual



1. Introduction	3	4. System Check	27
Principles of Weather Based Water Management	3	System Check	27
The Weather Reach Water Management System	4	Control Mode	27
Getting to Know your Rain Bird ET Manager	5	Weather Signal Test	28
LCD Display	5	Valve Control Test	29
Valve Group A & B Indicator Lights	6	Water Window Settings	29
Attention Indicator Light	6	Initial Moisture Levels	29
Cursor and Navigation Buttons	6	5. Routine Operation	30
Override Button	7	Weather Information	30
Terminal Cover	7	Irrigation Status	31
Specifications	7	Information Log	33
Resource CD Included with your ET Manager	8	Status Messages	34
Getting Ready to use Your ET Manager	8	Attention Messages	35
2. Installation	9	6. Determining Programmable Settings	41
Warnings	9	Site Assessment	41
Installation Check List	9	Sprinkler Controller and Station Information	42
Select Location	9	Landscape Conditions	43
Mounting	10	ET Manager Settings	44
Wire Connections	11	Irrigation Control	44
Grounding	12	Advanced Settings	46
Power	12	ET Manager Scheduler	47
Wiring Diagrams	13	7. Troubleshooting	48
Optional Rain Gauge	13	ET Manager Troubleshooting	48
Optional External Antenna	15	Water Management Troubleshooting	49
Install Battery	16	8. Advanced Output Methods	53
3. Programming	17	Enable A then B	53
Programming Options	17	ET & Rain Pulse	55
Using the ET Manager Programming Software	17	ET Pulse with Weather Interrupt	57
Manual Programming	17	Using More than One Sprinkler Controller	59
Manual Programming Steps	17	9. Appendices	60
1. Data Source	17	Appendix I. ET Manager Menu Structure	60
2. Output Method	19	Appendix II: Default ET Manager Settings	62
3. Site Specific Settings	19	Appendix III. ET Manager Site Assessment Worksheet	63
Irrigation Amount and Adjustment	19	Appendix IV. Soil Texture by Feel Diagram	64
Water Window	20	Appendix V. Calculating Precipitation Rates and Station Run Times	65
Available Watering Days	21	Appendix VI. ET Manager Settings Worksheet	66
Advanced Settings	21	Appendix VII. Sprinkler Controller Programming Worksheet	67
4. Additional Settings and Options	24	Appendix VIII: ET Manager Installation Checklist	68
Programming the Sprinkler Controller	25	Appendix IX. ET Manager Status Report Worksheet	69
Watering Days	25	Appendix X. Master Valve and Pump Control Installation with ET Manager	70
Cycle Start Times	26	10. Glossary	73
Station Run Times	26	Rain Bird's Professional Customer Satisfaction Policy	79
Non-ET Based Watering Schedules	26		

1. Introduction

Congratulations on purchasing the Rain Bird ET Manager! Your ET Manager (ETMi) works with almost all sprinkler controllers to automatically control watering based on current weather conditions bringing smart control to your sprinkler system. Weather conditions affect how much water your landscape needs. With your ET Manager landscape watering will be fully automatic and more accurate.

Principles of Weather Based Water Management

There are four key principles to the operation of the ET Manager.

Principle #1:

The soil is a reservoir: The purpose of watering is to replenish the soil reservoir, which makes water available for plants (see Figure 1). This reservoir has a limited capacity based on soil type and root depth.

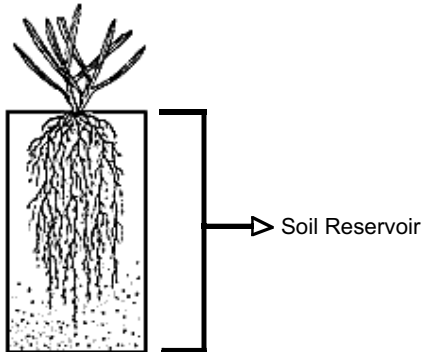

Figure 1. Soil Reservoir

Principle #2:

Weather Affects Landscapes: Landscapes need water at changing rates based on weather conditions. Water leaves plants and soil through evaporation. Because weather has a direct affect on evaporation, changing weather conditions have an effect on how often landscape watering is needed.

Principle #3:

Evaporation can be measured based on weather conditions: Landscape, golf, and agricultural water managers have been using weather stations to measure the loss of soil moisture caused by evaporation for over 20 years.

Evapotranspiration, or ET, is a measurement of water that evaporates into the air from the soil and the amount of water that is used (transpired) by a plant. ET is used to determine how much water must be returned to the landscape, either by rainfall or by using a sprinkler system. ET is typically expressed in hundredths of inches of water per day. ET losses are calculated using meteorological data measured with a weather station. Weather parameters used to calculate ET include: solar energy, air temperature, wind speed, humidity, and rainfall.

Figure 2 shows that ET is highest in the hot summer months, the time when your landscape needs the most water. Landscape, golf, and agricultural water managers have been using weather stations to measure the loss of soil moisture caused by evaporation for over 20 years.

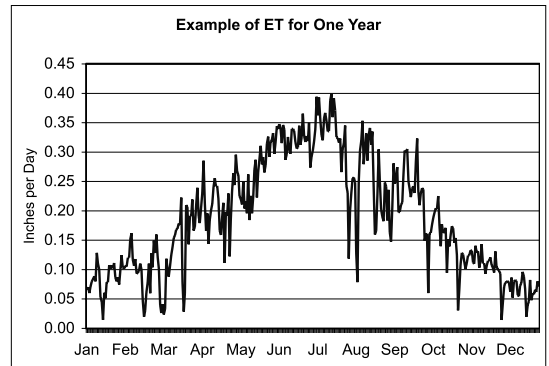

Figure 2. Example of Evapotranspiration for One Year

Principle #4

Technology can provide automated watering: The ET Manager uses current weather conditions to automatically control watering.

The Weather Reach Water Management System

Your ET Manager receives a wireless weather signal from the Weather Reach Water Management System. The Weather Reach Water Management System (Figure 3) automates commercial and residential sprinkler schedules using real-time weather conditions. A Weather Reach Signal Provider (WRSP) retrieves information from local weather stations. The information is broadcast as a weather signal via a paging radio frequency to your ET Manager. The weather signal contains the most recent weather conditions including:

- Solar Energy
- Temperature
- Wind
- Humidity
- Rainfall

The ET Manager uses this data to compute water loss and control how often your sprinkler controller waters your landscape.

*Weather Reach is a trademark of Irrisoft, Inc.

Weather Reach Signal Provider

Your Weather Reach Signal Provider (WRSP) retrieves weather information from local weather stations and sends the weather signal to your ET Manager. Your WRSP communicates with your ET Manager using Signal Provider Codes (see chapter 4, Programming) programmed into your ET Manager. The Signal Provider Codes are available from www.rainbird.com/etmanager, where you can download and print an information sheet with specific information regarding your local WRSP.

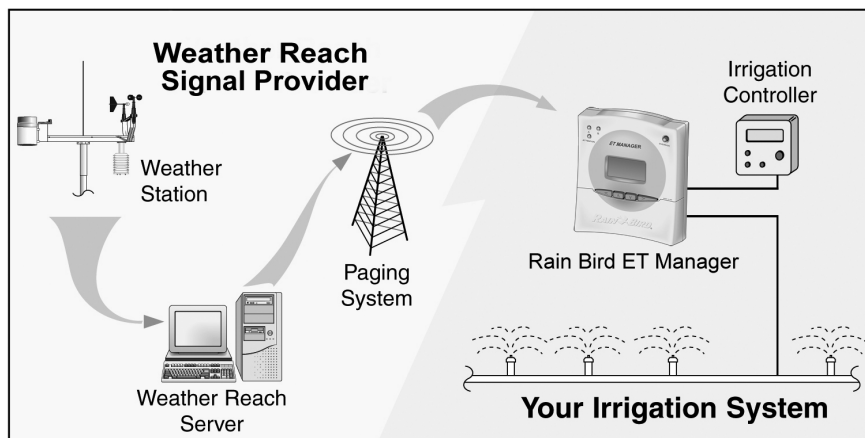

Figure 3. Weather Reach Water Management System

Getting to Know your Rain Bird ET Manager

Your ET Manager automates control of the sprinkler system. It reacts to weather information it receives from the weather signal based on the settings programmed in the device. The following basic knowledge will identify elements of the ET Manager (see Figure 4), explain how to navigate through the ET Manager menus, and provides ET Manager Specifications.

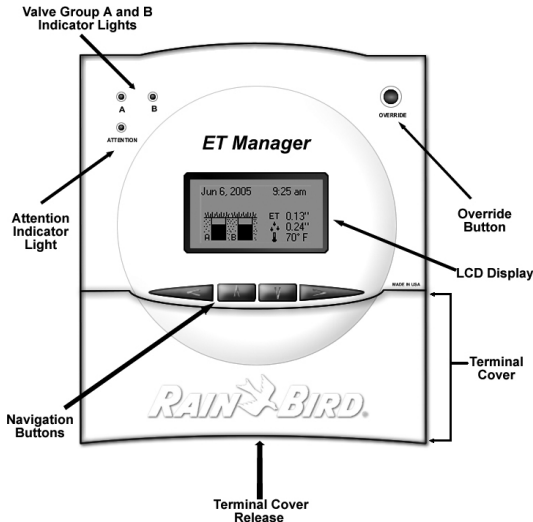
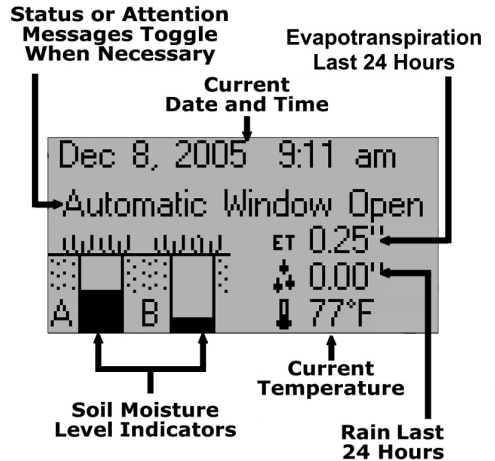

Figure 4. ET Manager Front Panel

LCD Display

The display is used to view current operating conditions, monitor status, view settings, and make programming changes. On startup the LCD screen displays the Home screen, which reports the following information:



Note: Status and Attention messages are a normal operation condition. Refer to chapter 5, Routine Operation, for more information on the Status and Attention messages.

Note: On initial startup the date and time is displayed as Jan 01 2000 12:00 am. Once the ET Manager begins to receive the weather signal the date and time will be set automatically. Date and time can also be set manually.



Note: After two hours with no keypad activity the display reverts to the Home screen.

Note: The LCD display will refresh once a minute.

Note: If you are using an advanced Output Method, as described in chapter 8, the Home screen may display different information.

LCD Contrast

The image contrast on the LCD may be adjusted if needed. Temperature and surrounding light conditions can affect image visibility. To adjust the contrast, from the Home screen press  once.

Once the contrast screen is displayed, press and hold  or  to adjust the image contrast. When the contrast is set to the desired setting, press  once to return to the Home screen.

The LCD contrast screen displays the ET Manager serial number, the program version of your device, and the date and time of the last signal.

Valve Group A & B Indicator Lights









Your ET Manager controls two valve groups. For example, Valve Group A can be assigned and wired to lawn stations and Valve Group B to shrub stations. There is one Indicator Light for each group of valves, "A" and "B."

A green light indicates watering is needed and the sprinkler controller will be allowed to activate a valve. A red light indicates watering is suspended or interrupted until watering is needed.

Attention Indicator Light

A yellow light, or the Attention Indicator Light, signals a condition that you should be aware of. An attention message is displayed on the Home screen. Please refer to chapter 5, Routine Operation, for more information on the attention messages.

Cursor and Navigation Buttons

To navigate ET Manager menus, you need to understand the movement of the cursor and its location. The  symbol indicates the current cursor location. The , , or  navigation buttons are used to position the cursor at the desired location.  is used to enter the selected menu. Once in the desired menu or position, use  or  to change a value or select an option.  is used to go back, or to exit the screen.

To practice navigating using the cursor and navigation buttons, try setting the Current Moisture Level for Valve Group A or B. Menu paths like the one below are found throughout the manual to show which items within the menu and submenu need to be selected to access key information or to adjust settings.



Example of a Menu path:

Main Menu  **Settings**  **Irrigation Status**
▶ "A" Moisture Level

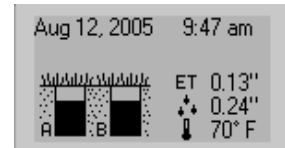

Below is a detailed explanation of how to follow this menu path through your ET Manager.

From the Home screen access the Main Menu by pressing .





In the Main menu, use the  or  to scroll to Irrigation Status and press .



In the Irrigation Status screen, use the  or  to scroll to "A" Moisture Level and press .



The  will be positioned at the value of the Current Level. Use  or  to adjust this level.

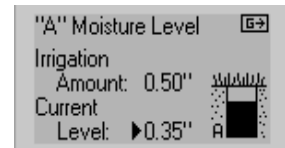

Once the amount is adjusted, use  to get back to the Irrigation Status screen.

1. Introduction

Override Button

If the A or B Indicator Light is red, your ET Manager is interrupting the output of the sprinkler controller. If you need to manually activate a valve from the sprinkler controller, press the Override button, and the Valve Group A and B Indicator Lights will turn green enabling sprinkler output. Your sprinkler controller can now be used to manually start a valve.



Once the Override button is pressed, the LCD display will change from the current screen to the Override screen.

An Override will allow watering for one hour, if more time is needed press the Override button again or press **▲** for each additional hour of Override. Once the override time has elapsed, watering will be interrupted as before. Press **▼** to 0 hours to end manual override in the ET Manager.

Terminal Cover

To access wire terminals, the terminal cover will need to be removed. Press gently on the terminal cover release while pulling out the bottom edge of the terminal cover. To completely remove the terminal cover, lift it off the tabs, exposing the wire terminals. To replace the terminal cover, insert the tabs into the tab holes, and the terminal cover release on the terminal cover until it is correctly positioned back in place.

Specifications

Electrical Specifications

- **Power Supply:** 12 to 30-volt AC/60Hz or 12 to 35 VDC @ 0.22 (0.2) Amp max
- **Contact Load:** 4 Amp max. @ 30-volt AC max
- **Operating Temperature Range:** -15° to 65°C (5° to 149°F)
- **Paging Radio Operating Temperature Range:** 0° to 50°C (32° to 122°F)
- **Terminal Wire Gauge:** 14 to 20 AWG
- **Ground Lug Wire Gauge:** 10 to 18 AWG
- **Serial Communications:** TTL level, 1x6 Header, requires WR-USB Personal Computer Interface
- **Antenna Connection:** BNC Female, 930 MHz
- **Rain Gauge Sensor Voltage:** 3.3 VDC

Cabinet - Indoor Wall Mount

- Width: 5.5"
- Height: 6.5"
- Depth: 1.9"

Note: The ET Manager is an indoor mount only unit, unless mounting outdoors with the ETM-OE.

Optional Accessories

- **PN 635640:** 110-volt AC Plug-in Power Supply Transformer
- **ETMi-ANT:** ET Manager Remote Antenna

Note: The ET Manager contains a paging radio receiver with a built-in antenna. Locations with a weak paging signal may require an external antenna.

- **ETM-OE:** ET Manager outdoor enclosure option made with heavy-duty weather resistant plastic and 110-volt AC outlets. This case is lockable and the dimensions are 11 $\frac{3}{8}$ " H x 9 $\frac{1}{2}$ " W x 4 $\frac{1}{4}$ " D
- **ETM-RG:** Tipping Bucket Rain Gauge (1mm/tip) w/ 30' Cable.

ET Formula

Evapotranspiration (ETc) is calculated by the ET Manager using data from the weather signal via the paging system. The ET Manager uses the Standardized Reference Evapotranspiration Equation with a short grass reference, prepared by the American Society of Civil Engineers.

Resource CD Included with your ET Manager

Included with your ET Manager is a resource CD containing helpful tools such as:

- ET Manager Simulation and Animations
- Printable versions of worksheets used and referred to in this manual
- Rain Bird ET Manager Scheduler
- Printable versions of application notes

Getting Ready to use Your ET Manager

The following chapters will walk you through how to install, program, and use your ET Manager.

- Installation, chapter 2
- Programming, chapter 3
- System Check, chapter 4
- Routine Operation, chapter 5
- Determining Programmable Settings, chapter 6
- Troubleshooting, chapter 7
- Advanced Output Methods, chapter 8
- Appendices, chapter 9
- Glossary, chapter 10

2. Installation

To install your ET Manager, follow the installation check list and instructions given in this chapter. Your ET Manager is compatible with almost any type of sprinkler controller. This chapter focuses on installing your ET Manager with a standard sprinkler controller. Refer to chapter 8 for specific installation instructions on installing your ET Manager with advanced sprinkler controllers.

Warnings

- The ET Manager is intended for indoor use. Outdoor installation locations require the use of an outdoor enclosure (ETM-OE).
- The ET Manager must be installed in compliance with local electrical codes.
- To prevent electrical shock and/or damage, make sure that all supply power is **OFF** to the device, the sprinkler controller, or any equipment being connected. Electrical shock can cause severe injury or death.
- 12 to 30-volts AC or 12 to 35-volts DC **MUST** be used to power this unit. **DO NOT** connect it to 120 volts or greater.
- A ground wire, 10-18 AWG, **MUST** be connected for electrical surge, equipment and personal protection.

Installation Check List

- Select Location
- Mounting
- Provide Power
- Grounding
- Wire Connections
- Optional Rain Gauge
- Optional External Antenna
- Install Battery

Select Location

Follow these guidelines to select a location for the ET Manager:

- It is best to install it adjacent to the sprinkler controller.
- The ET Manager is not weather resistant. **Install indoors ONLY unless using a weather resistant enclosure (ETM-OE or TC-2).**
- Optional outdoor enclosures designed for the ET Manager are available. Use the model ETM-OE.
- Avoid electromagnetic interference. **DO NOT** install the ET Manager near motors, transformers or other high current electric equipment.
- Mount near eye level for easy viewing.

Mounting

Before mounting make sure the power is disconnected, and remove the terminal cover. Press gently on the terminal cover release while pulling out the bottom edge of the terminal cover. To completely remove the terminal cover, lift it off the tabs, exposing the wire terminals.

The ET Manager has four mounting holes on the back of the cabinet; three keyhole slots and one round hole at the bottom. Use the ET Manager Template provided with the ET Manager packaging to aid with mounting (see Figure 5).

Select a suitable indoor location as near to the sprinkler controller as possible. The ET Manager is designed and warranted for indoor use only and must be installed in a weatherproof enclosure (Model ETMi-OE) for outdoor installations.

Note: The ET Manager receives a wireless radio signal from an existing paging system. When choosing a mounting location, avoid locations that may cause radio signal interference. Close proximity to radio transmit-

ters and electrical equipment is the most common cause of radio frequency interference. Other causes of radio frequency interference are high voltage areas, microwave ovens, and arc welding.

Using a Philips head screwdriver install two of the provided mounting screws to the wall 4" apart for the two outside upper keyholes. For narrow stud installations, install one mounting screw in the middle keyhole.

Position the ET Manager keyhole slots over the mounting screws. Slide the ET Manager down so the screw head shaft fits in the narrow part of the keyhole. Verify the ET Manager is snug against the mounting surface. If necessary, tighten the mounting screws carefully so as not to damage the ET Manager.

Install the remaining mounting screw through the lower mounting hole. This can be accessed through the round hole above the wire terminal strip. Confirm the ET Manager is securely mounted.

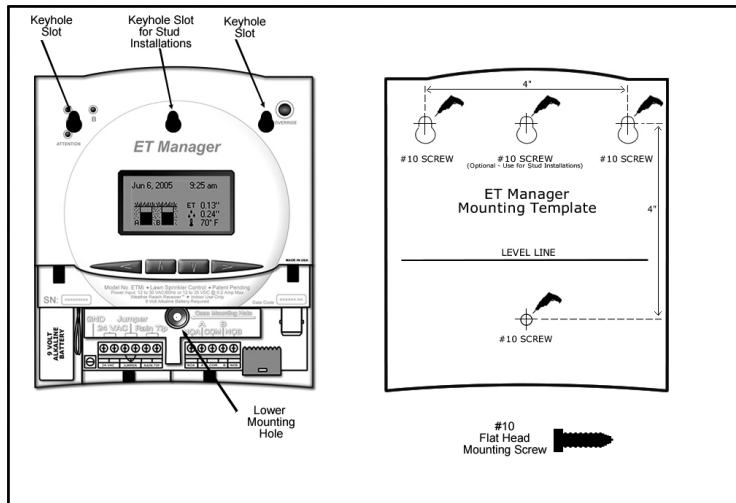

Figure 5. Mounting your ET Manager

2. Installation

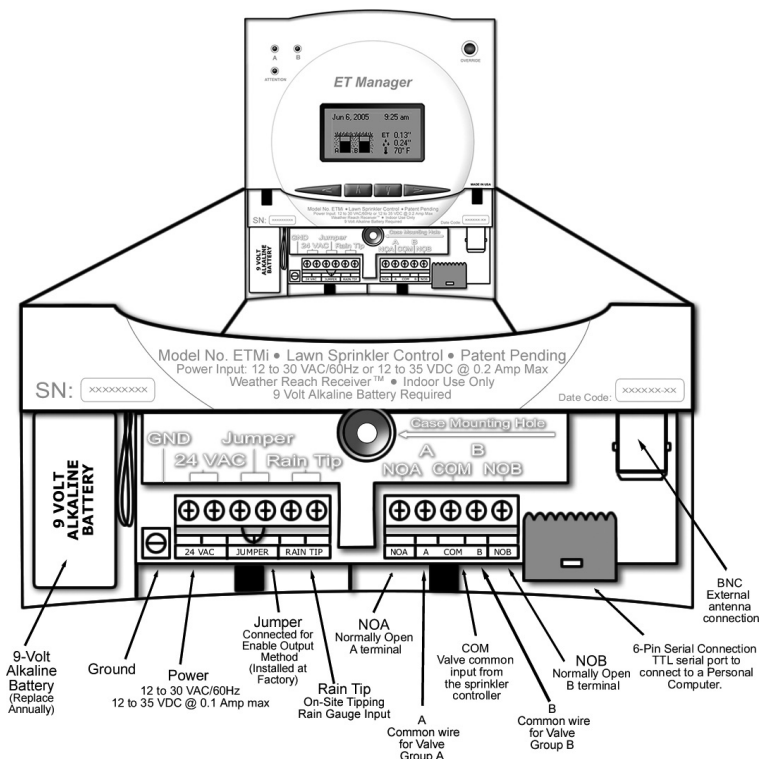

Figure 6. ET Manager Wire Terminal Connections

Wire Connections

Behind the terminal cover there are the following wiring terminals (see Figure 6):

- **9-volt Battery:** Connect 9-volt alkaline battery, to be replaced annually or as needed
- **Ground:** Earth ground for surge protection
- **Power:** 12 to 30-volt AC/60Hz or 12 to 35 VDC @ 0.22 (0.2) Amp max
- **Jumper:** Connected for Enable Output Method
- **Rain Tip In:** On-site tipping bucket rain gauge input
- **NOA:** Normally Open A terminal used for ET Pulse
- **A:** Valve Group A Common wire
- **COM:** Valve common input from the sprinkler controller
- **B:** Valve Group B Common wire
- **NOB:** Normally Open B terminal used for Rain Pulse
- **6-Pin Serial Connection:** TTL serial port to connect to a Personal Computer, requires the ET Manager Programming Software (ETM-PS) (sold separately)
- **BNC:** External antenna connection

Wire Connection Guidelines

- Strip approximately ¼" insulation off the ends of wires connected to the ET Manager, and strip insulation off the ends of other wires as needed.
- Use an appropriate screwdriver for all mounting.
- Use a thin blade screwdriver for all ET Manager wire terminal connections.
- Use appropriate screwdriver for all wire connections to sprinkler controller.
- Use proper wire gauges, 14-26 AWG for terminal connections, and 10-18 AWG for grounding.
- Use proper wire ties.
- Verify each wire connection is secure.
- Use a Volt-Ohm meter to test and verify common wires and power source voltage.

WARNING: To prevent electrical shock make sure the power supply is **OFF** before connecting wires to any of the devices. Electrical shock can cause severe injury or death.

Grounding

Connect a 10, 12, 14 or 18-gauge ground wire to earth ground. Strip approximately 1/4" insulation from the end of the ground wire and connect to the ET Manager ground connection using a thin blade screwdriver. Give the wire a gentle tug to verify it is secure.

GROUNDING IS ESSENTIAL for electrical surge protection and personal protection.

Note: 10 AWG is preferred for grounding your ET Manager.

Power

WARNING: To prevent electrical shock, damage to the ET Manager, or damage to your sprinkler controller, make sure the power supply is **OFF** before connecting wires to any of the devices. Electrical shock can cause severe injury or death.

All electrical connections and wire runs must be made in accordance with local building codes.

The power requirement is 12 to 30-volts AC or 12 to 35-volts DC and draws a maximum 0.22 (0.2) Amp max. Power for the ET Manager can come from one of two sources:

Power Option 1

The ET Manager can be connected to a 24-volt AC source within the sprinkler controller. The current draw is 0.22 (0.2) Amps (less than one standard valve solenoid). Check the sprinkler controller owner's manual to verify that accessory devices can be powered from the sprinkler controller power supply.

Connect a 14 or 18 AWG wire to the sprinkler controller 24-volt AC power supply. Strip approximately ¼" insulation from the ends of the power wires. Using a thin blade screwdriver, connect the wires to the ET Manager power terminals labeled "24 VAC." Give the wires a gentle tug to verify they are secure.

Power Option 2

Use a Rain Bird ETMi 120-volt AC Plug-in Transformer 635640 (Model ETMi-TRAN). Using a thin blade screwdriver, attach the two orange wire ends of the transformer to the 24-volt AC wire terminals on the ET Manager wire terminal strip. If an adequate ground is not connected, as described above, attach the green ground wire, to the ET Manager ground connection using a thin blade screwdriver. Give the wires a gentle tug to verify they are secure. Plug power supply into a 120-volt AC outlet.

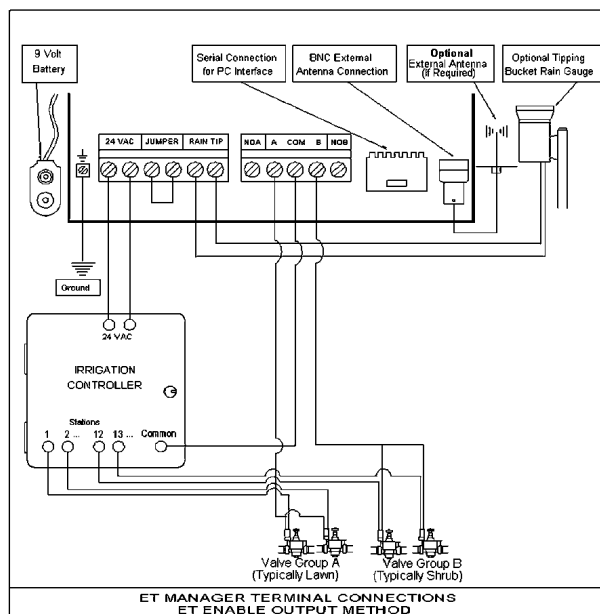

Figure 7. ET Manager Terminal Connections - ET Enable Output Method

Wiring Diagrams

The most common Output Method for the ET Manager is to interrupt the valve common output of a sprinkler controller until watering is needed. This is referred to as the “Enable” Output Method. The ET Manager can support two Valve Groups, A and B. The valve common from the sprinkler controller is wired into the ET Manager and the Valve Groups A and B common wires run from the ET Manager to the sprinkler control valves. A separate common wire is required for each valve group. See Figure 7 for the Enable Output Method wiring diagram.

Note: The wiring diagrams for advanced Output Methods are included in chapter 8.

Optional Rain Gauge

Rain measurements are provided from the remote weather station operated by the WRSP. If site-specific rainfall measurements are desired, mount the optional on-site tipping rain gauge (Model ETM-RG). The optional rain gauge will be used by the ET Manager in place of the weather station rain information.

A local on-site rain gauge can be connected to the ET Manager. The rain gauge must be a tipping gauge with an output measurement at either 0.01" or 1.0 mm per tip. The on-site rainfall value can be used in place of the rainfall value broadcast in the weather signal to provide actual on-site rain data.

The Tipping Rain Gauge (Model ETM-RG) is an optional rain gauge available from Rain Bird for use with the ET Manager. The rain gauge contacts can be either normally open or normally closed.

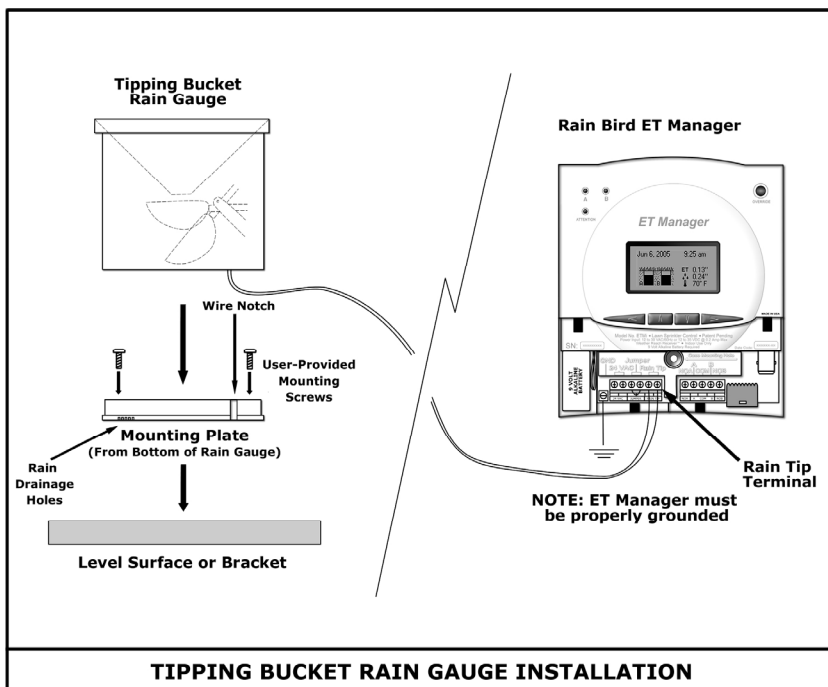

Figure 8. Tipping Bucket Rain Gauge Installation

Note: Traditional “rain sensors” do not measure the amount of rain and must NOT be connected to the ET Manager.

There is an optional rain gauge available from Rain Bird approved for use with the ET Manager. The rain gauge contacts can be either normally open or normally closed.

- ETM-RG - Tipping Bucket Rain Gauge (1mm/ tip) w/ 30' Cable

Note: Power to the ET Manager **MUST BE DISCONNECTED** when connecting a rain gauge. Follow these steps when installing an optional rain gauge:

1. Identify a mounting location that will:
 - a. Catch natural rain.
 - b. Not be blocked by obstructions.
 - c. Not be vandalized.
 - d. Not collect sprinkler water.
2. Prepare mounting surface.
3. Remove mounting plate and secure to mounting surface.
4. Reattach rain gauge to mounting plate, verify the spoon orientation is over the drain holes (see Figure 8).
5. Route and secure the wires to ET Manager.
6. Connect wires to the ET Manager Rain Tip In wire terminal, and give the wires a gentle tug to ensure connection.

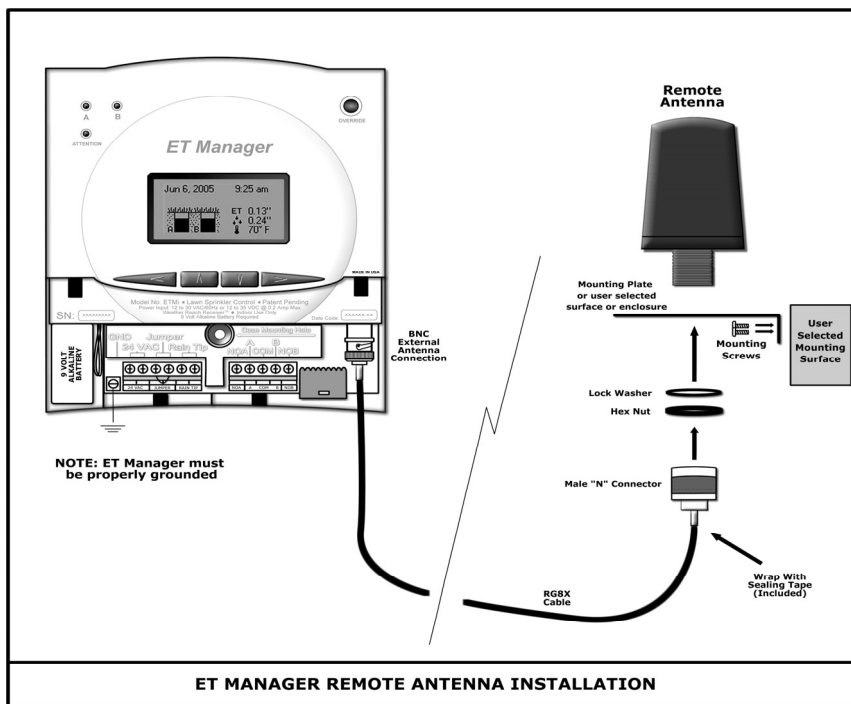

Figure 9. External Antenna Installation

Optional External Antenna

Your ET Manager contains a paging radio receiver with a built-in antenna. In most cases this antenna will be sufficient. Conduct the Weather Signal Test from chapter 4, System Check. If the weather signal is regularly missed by the built-in antenna, an external antenna may be connected and mounted in a different location for better reception. Use the Rain Bird ET Manager Remote Antenna Kit (ETMi-ANT) to improve radio reception.

The ET Manager Remote Antenna Kit includes:

- Permanent Mount Antenna
- Mounting bracket
- Mounting screws
- 15 feet of RG8X cable with N style male connector and BNC male connector

- Self-fusing silicone sealing tape

Follow these steps when installing an optional external antenna:

1. Identify a mounting location that will:
 - a. Allow antenna to be mounted vertically.
 - b. Improve radio reception.
2. Install the mounting bracket or prepare the mounting surface.
3. Remove protective cap, mounting nut and washer from the antenna.
4. Insert bottom of antenna into the mounting surface.
5. Reattach mounting nut and washer to the bottom of the antenna.

6. Attach the N style male connector to the bottom of the antenna.
7. Run the RG8X cable to the ET Manager, and connect the BNC male connector to the ET Manager BNC External Antenna Connection.
8. Seal each cable connection using the provided self-fusing silicone sealing tape.
9. Conduct the Weather Signal Test from chapter 4, System Check. If the weather signal continues to be regularly missed with proper installation of the remote antenna, contact Rain Bird for other options.

Note: Use of the ET Manager Remote Antenna Kit may not assure reception in all areas due to local radio signal conditions. For information on other options when encountering poor radio signal conditions contact Rain Bird for additional options.

Note: If cable length is inadequate contact Rain Bird for custom cable lengths.

Install Battery

A 9-volt alkaline battery should be installed in your ET Manager to the 9-volt battery connection. The battery will assure time keeping continues during a power outage. It should be replaced annually or as needed.

If a power outage occurs, ET Manager control will be interrupted. The sprinkler controller will activate station valves as programmed without ET Manager control. The Valve Group A and B Indicator Lights will go off. A status message will be displayed on the Home screen indicating “No Power.” The weather signal will not be received. If there are signals missed during a power outage, the ET Manager recognizes the missed signal and estimates ET for the missed period.

If there is no power, the ET Manager can be programmed using battery power. It takes several button pushes to “wakeup” the processor to allow menu navigation.

3. Programming

Your ET Manager operation requires programming specific settings. Most of the programmable settings are site specific and are defined in chapter 6, Determining Programmable Settings. This chapter will allow you to program your ET Manager using general settings; refer to Appendix II for a table of general programmable settings.

Programming Options

There are two programming options for an ET Manager:

- Using the ET Manager Programming Software
- Manual Programming

Using the ET Manager Programming Software

The ET Manager Programming Software (ETM-PS) is a software program that simplifies ET Manager programming. The ETM-PS allows you to connect your ET Manager to a personal computer to perform several key functions:

- Choose your WRSP and weather region from pull downs.
- Program all settings quickly and easily.
- Save programmable settings for future use.
- Use ET Manager Scheduler to help automatically set site specific settings for your ET Manager.
- Access ET Manager diagnostic tools.
- Provides a printable report of programmed settings.

The ETM-PS software is sold separately. For ET Manager Programming Software information, contact your Rain Bird Distributor.

Note: If your ET Manager has been previously programmed you should have received an ETM-PS report. This report is a summary of programmed settings. You should review these settings to verify they correspond to the actual site conditions.

Note: The yellow Attention Indicator Light may be on when power is connected to the ET Manager. Attention condition messages may be displayed on the Home screen. Initially, the “Set Signal Provider Code” and “No Historical ET Data” messages may be displayed. Once these settings are programmed, the yellow Attention Indicator Light will turn off and the attention messages will disappear.

Manual Programming

Manual programming allows you to program each setting on-site or in the field using the buttons and menus built into the ET Manager. Manual programming can be more time consuming than using the ET Manager Programming Software.

Manual Programming Steps

Manual programming can be broken into 4 key steps:

1. Data Source
2. Output Method
3. Site Specific Settings
4. Additional Settings

Note: Appendix I, ET Menu Structure, is available for easy viewing of the ET Manager menus.

1. Data Source

Specific settings must be programmed to obtain access to the appropriate weather information. These settings include:

- Weather Region
- Rain Source
- Elevation
- Signal Provider Code

Weather Region

Main Menu ► Settings ► System ► Data Source
► Weather Region

The weather region number represents a weather station assigned by the WRSP. The weather region you set should correspond to a weather station that closely represents the location of the ET Manager. To obtain your weather region number, contact your WRSP, the Rain Bird Distributor, your installation contractor, or go to www.rainbird.com/etmanager.

To set the weather region, navigate the menus to Weather Region, press **▶** to move the cursor location to the number and use the **▲** or **▼** to enter the weather region number.

Rain Source

Main Menu ► Settings ► System ► Data Source
► Rain Source

The rain source may come from:

- **Signal:** Use the rain value in the weather signal from the selected weather region.
- **Local (1mm per tip):** Use an on-site tipping bucket rain gauge connected to the Rain Tip-in terminal that measures rain with a 1mm per tip signal (ETM-RG Tipping Rain Gauge).
- **Local (0.01" per tip):** Use an on-site tipping bucket rain gauge connected to the Rain Tip-in terminal that measures rain with a 0.01" per tip signal.
- **Rain Region:** Like the weather region number, a rain region number represents an area where customers share data. Within an area, one on-site tipping bucket rain gauge is used to share localized rain data among ET Manager customers, allowing for a more accurate representation of local rain. Your WRSP broadcasts rain region data.

To set the rain source, navigate the menus to Rain Source, press **▶** to enter into the Rain Source screen. Press **▶** once more to change the • to the cursor, **▶**. Use the **▲** or **▼** to select the rain source.

If the rain region is selected, press **▶** to move the cursor location to the rain region number and use the **▲** or **▼** to enter the rain region number.

Elevation

Main Menu ► Settings ► System ► Data Source
► Elevation

Elevation above sea level is used when calculating ET. To enter a close estimation of your elevation, navigate the menus to Elevation, press **▶** to move the cursor location to the elevation, and use the **▲** or **▼** to set the elevation.

Signal Provider Code

Main Menu ► Settings ► System ► Data Source
► Signal Provider Code

Your ET Manager must be programmed to receive information from your specific WRSP. A Signal Provider Code is unique for your WRSP and is necessary for your ET Manager to receive a weather signal. The code consists of 10 different numbers and these 10 numbers are labeled A-J. To obtain this code, contact your WRSP, the Rain Bird Distributor, your installation contractor, or go to www.rainbird.com/etmanager.

Navigate the Menus to the Signal Provider Code and press **▶** to enter into the Signal Provider Code screen.

Press **▼** to move the cursor to "Yes" and press **▶**. Use the **▲**, **▼** and **▶** buttons to set the codes for A through J.

```
SIGNAL PROVIDER CODE
▶ A:      0
  B:     107
  C:      94
  NEXT
```

2. Output Method

To accommodate almost any type of sprinkler controller, the ET Manager has four Output Methods:

Standard

- **Enable:** This is the most common setting. A sprinkler controller output is *enabled* to allow watering only when needed.

Advanced

- **Enable A then B:** This output operates the same as the “Enable” method with one significant difference. There may be instances when watering needs to be spread over two days. The Enable A then B mode allows watering on only one valve group per day, then alternates to the other valve group on the next available day.
- **ET and Rain Pulse:** Advanced ET-based controllers can recognize ET and Rain pulse inputs.
- **ET Pulse with Weather Interrupt:** ET Pulse with Weather Interrupt is similar to ET and Rain Pulse with a second output acting as a sensor interrupt to prevent watering if any one of the three Weather Interrupt conditions occurs; rain, freezing conditions or high wind.

If not using Enable, review chapter 8, Advanced Output Methods.

Output Method

Main Menu ► Settings ► System ► Output Method

Navigate the menus to the Output Method. Press **▶** and you will see the current output method your ET Manager is programmed to. Press **▶** to see the list of available Output Methods. A bullet • marks the current selection. Press **▶** again to move the **▶** cursor to the list. Use **▲** or **▼** to change the Output Method. Once you have selected the Output Method, use **◀** to exit the screen.

3. Site Specific Settings

Site specific settings are programmed to meet the needs of your landscape and sprinkler system. From Settings in the Main Menu access:

- **Irrigation Control**
- **Weather Interrupt**

Note: Refer to Appendix II for default settings, or to chapter 6, Determining Programmable Settings to establish site specific ET Manager settings.

Irrigation Control

Main Menu ► Settings ► Irrigation Control

Irrigation control settings are based on site specific conditions. Plant type, soil type, sprinkler system capabilities, and available watering periods affect these settings:

- **Irrigation Amount & Adjustments**
- **Water Window**
- **Available Watering Days**
- **Advanced Settings**

Irrigation Amount and Adjustment

Main Menu ► Settings ► Irrigation Control
► Irrigation Amount and Adj

The Irrigation Amount represents how many inches (or mm) of water is applied to your landscape for Valve Group A and Valve Group B during each watering cycle. This amount of water evaporates from your landscape before the ET Manager will allow watering to occur.

The Landscape Adjustment Percentage is used to adjust for site-specific landscape needs for Valve Group A and Valve Group B. The Landscape Adjustment Percentage is applied to the calculated ET, and effects the current Moisture Levels for Valve Groups A and B.

Refer to Determining Programmable Settings, chapter 6, for more information on determining the values for the Irrigation Amounts and Landscape Adjustment Percentages.

Navigate to Irrigation Amount & Adjust, and press **▶**. The cursor will be pointing to Irrigation Amount. Now press **▶** once to position the cursor to the "A." Use **▲** or **▼** to choose between A and B. Press **▶** when the cursor is in front of the valve group you would like to adjust. Use **▲** or **▼** to adjust the Irrigation Amount for A and B. Once the Irrigation Amount is adjusted, use **◀** twice to get back to the Irrigation Amount field.

Note: If only one of the two Valve Groups is used, you can "turn off" the remaining Valve Group by programming the Irrigation Amount to zero.

To set the Landscape Adjustment, press **▼** placing the cursor in front of Landscape Adjustment. Press **▶** once to position the cursor to the "A" and twice to position the cursor to the B value. Use **▲** or **▼** to adjust the Landscape Adjust for A and B.

Water Window

Main Menu ▶ Settings ▶ Irrigation Control
▶ Water Window

The ET Manager Water Window needs to be synchronized with the first sprinkler controller start time and the length of all watering cycles. There are two Water Windows used to manage the system:

- **Automatic Window:** The period of time that the ET Manager controls watering cycles based on ET.
- **Daily Window:** An optional period when watering occurs as programmed in the sprinkler controller as non-ET based watering schedules not controlled by the ET Manager. During this period of time, watering will not be controlled by the ET Manager.

To avoid overlapping between the Automatic and Daily Windows, the ET Manager restricts at least one hour separation between the beginning and ending of each Water Window. If there is no Daily Window programmed, the Daily Window time range will be displayed as "Off."

There are two steps to program the Automatic Window:

1. Program the beginning of the Automatic Window. The position of the cursor will be at Automatic Window. Press **▶** to move the cursor to the opening time of the Automatic Window. Use **▲** or **▼** to set the opening time, synchronized to the first start time programmed in the sprinkler controller.

```

WATER WINDOW
▶ Automatic Window
  10:00 pm to 8:00 am
  Daily Window
    9:00 am to 10:00 am
    
```

2. Press **▶** to program the end of the Automatic Window. Use **▲** or **▼** to set the length of time for the Automatic Window. The Automatic Window should be the total length of time it takes to complete all watering cycles. When finished, press **◀** twice to exit from the Automatic Window.

```

WATER WINDOW
  Automatic Window
    10:00 pm to ▶ 8 hours
  Daily Window
    7:00 am to 10:00 am
    
```

The steps to programming the Daily Window are similar to programming the Automatic Window.

Note: If you do not want to program a Daily Window, set your start time and ending time to the same hour, and OFF will appear under the Daily Window.

```

WATER WINDOW
  Automatic Window
    10:00 pm to 6:00 am
  ▶ Daily Window
    (Off)
    
```

Note: The display changes from the closing time to a length of time when programming the Water Window settings. For example, if the Automatic Window is set

3. Programming

from 10:00 pm to 8:00 am, once you press ◀ your ET Manager will display 10:00 pm for 10 hours.

Note: Use a separate sprinkler controller program for non-ET based watering schedules.

Available Watering Days

Main Menu ▶ Settings ▶ Irrigation Control
▶ Available Watering Days

The days available for watering can be programmed in your ET Manager or your sprinkler controller. Typically Available Watering Days are set to “all” or everyday. The days available for watering could be limited because of scheduled maintenance, facility use, or local watering restrictions.

To program the Available Days go to the Available Days screen, press ▶, and use ▲ or ▼ to position the cursor on the selected option. Watering days can be set to:

- **All:** Water on any day of the week.
- **Even:** Water only on even days of the week.
- **Odd:** Water only on odd days of the week.
- **Odd Off 31:** Water only on odd days of the week, and watering will not occur on the 31st of the month.

- **Custom:** The user can limit the days of the week that watering can occur. When choosing custom, press ▶ to advance to the next screen. On these screens selected days can be turned “On” or “Off.” Use the arrow keys to select the desired day, and then use ▶ to move the cursor to the “On” or “Off” setting. Use ▲ or ▼ to toggle between “On” or “Off.” Use ◀ to go back. Repeat for all days, advance to the next screen and continue until all days are programmed.

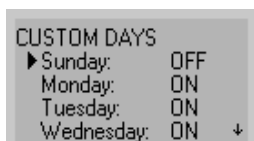

Look-Ahead Feature: If Available Days is not programmed to “All” and specific days are not available, the ET Manager looks ahead to determine if watering should occur even though the Moisture Level has not reached “0.”

When the Automatic Window opens, it checks to see if the next watering day is an available water day. If the next day is a “No Water Day” and it determines that watering would most likely occur on that day, watering will be enabled. The ET Manager looks at the current Moisture Level and current ET and allows watering, even if the Moisture Level has not reached “0.”

Note: When restricting available watering days, the Water Window must begin and end either before midnight, or after midnight. If your Water Window is programmed to run through midnight, you must set available days to all in the ET Manager. You can still program off days by turning days off on your sprinkler controller. A sensor built into your ET Manager will recognize off days scheduled into your sprinkler controller. The Look-Ahead Feature will not function.

Note: Available days can affect the Daily Window setting. If days are restricted, the Daily Window does not allow watering on the restricted day.

Advanced Settings

Main Menu ▶ Settings ▶ Irrigation Control
▶ Advanced Settings

The Advanced Settings menu provides additional control features using the ET Manager. These settings include:

- Effective Rain
- Signal Crop Coefficient
- Wind Adjust %
- Historical ET

Effective Rain Settings

Main Menu ► Settings ► Irrigation Control
► Advanced Settings ► Effective Rain Settings

Not all rainfall measured is considered effective rain. Rain that falls too quickly will run off before reaching the root zone, and rain that falls when the soil is completely saturated will run off as well. The Effective Rain settings include:

- **Max Hourly Rain:** The Maximum Hourly Rain is the maximum amount of rain that will be accepted each hour in the soil moisture level.
- **Saturation Allowance for A and B:** The Saturation Allowance is equal to the amount of rain it takes to saturate the soil after satisfying the Irrigation Amount and before runoff occurs.

Navigate the menus to the Advanced Settings screen, and press ► on Effective Rain Settings screen. The ► will be at Max Hourly Rain, press ► to move the cursor to the Max Hourly Rain value, and use ▲ or ▼ to adjust the value. Use ◀ to go back to set the Saturation Allowance for A and B. Once the ► is located at Saturation Allowance, press ► once to move the cursor to A and twice to B. Use ▲ or ▼ to adjust these values.

Signal Crop Coefficient

Main Menu ► Settings ► Irrigation Control
► Advanced Settings ► Signal Crop Coefficient

The WRSP includes a Signal Crop Coefficient percentage in the weather signal. A Signal Crop Coefficient (Kc) adjusts ET to a specific crop and can change over the year due to seasonal conditions ($ETos \times Kc = ETc$).

You can choose to use or ignore the Signal Crop Coefficient. After navigating to the Signal Crop Coefficient screen, press ► to change the • to ► and use ▲ or ▼ to “Use” or “Ignore” the crop coefficient included in the weather signal. In most cases this is set to “Use.”

Note: You can view the Signal Crop Coefficient percentage from:

Main Menu ► Irrigation Status ► Evaporation (ET)
► Signal Kc

Wind Adjust

Main Menu ► Settings ► Irrigation Control
► Advanced Settings ► Wind Adjust %

The wind speed measurement included in the weather signal can be scaled by a percentage to compensate for variations in prevailing conditions. Press ► to move the cursor to the percentage and use ▲ or ▼ to adjust the value.

Historical ET

Main Menu ► Settings ► Irrigation Control
► Advanced Settings ► Historical ET

The ET Manager can be set to operate using historical ET data, instead of the weather signal data. If a problem occurs and the ET Manager is not receiving the weather signal, it will continue to operate using historical ET data as a default ET. This setting represents an average daily ET for each month. To obtain the average daily historical ET for your area, go to www.rainbird.com/etmanager and download your Weather Reach Signal Provider Information Sheet.

From the Historical ET screen, the cursor location will be at January. To enter January daily ET average, press ► moving the cursor location to the ET value.

Use ▲ or ▼ to adjust the ET value, and press ◀ to move the cursor back to the list of months. Scroll down to the next month and repeat the process for each month.

Your ET Manager uses the programmed daily historical ET at the first of each month, and then looks at the next month value to make an ET curve to determine historic ET values for each day of the month (see Figure 10).

```
HISTORICAL ET avg/day
► January: 0.04"
February: 0.07"
March: 0.10"
NEXT
```

3. Programming

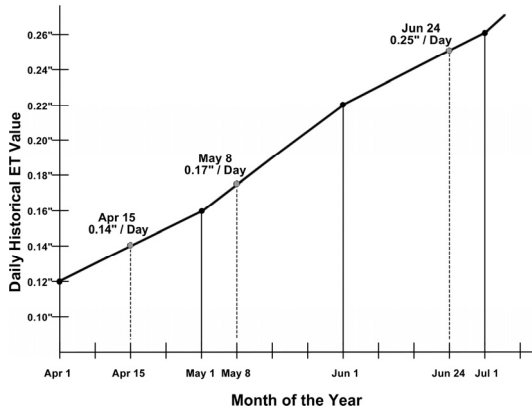

Figure 10. ET Manager Using Historical ET Data

Note: A Historical ET database is available in your Rain Bird ET Manager Scheduler program found on the provided CD.

Weather Interrupt

Main Menu ► Settings ► Weather Interrupt

Your ET Manager receives current weather information from the local weather station. The ET Manager can be programmed to interrupt watering in the event an adverse weather condition occurs. There are four “sensor interrupt” conditions that may be programmed:

- Low Air Temperature
- High Wind
- Rain 24 Hour
- Rain 1 Hour

To program a Weather Interrupt setting, from the Settings screen, press ► when the cursor location is at Weather Interrupt. Use ▲ or ▼ to move the cursor location in front of each Weather Interrupt, and press ►. Use ▲ or ▼ to adjust the interrupt value, and press ◀ to move the cursor back to the list of interrupts.

Low Air Temperature

If the hourly weather signal contains air temperatures that reach the Temperature Interrupt setting, watering is interrupted. The Weather Interrupt is cancelled once the air temperature rises above the programmed interrupt setting received in the hourly weather signal. This interrupt will prevent watering during freezing conditions.

High Wind

If the hourly weather signal contains wind speeds that reach the Wind Interrupt setting, watering is interrupted. The Weather Interrupt is cancelled once the wind speed decreases below the programmed Wind Interrupt setting. This interrupt will prevent watering during high wind conditions.

Rain 24 Hour

Your ET Manager will look at rainfall for the last 24 hours. If rain accumulations reach the programmed Rain 24 Hour Interrupt setting, watering is interrupted. The Weather Interrupt is cancelled once the total rainfall in the last 24 hours drops below the Rain 24 Hour setting. This interrupt will prevent watering when rainfall is received.

Rain 1 Hour

Like the Rain 24 Hour setting, your ET Manager will look at rainfall for the last hour. If rain accumulations reach the programmed Rain 1 Hour Interrupt setting, watering is interrupted. The Weather Interrupt is cancelled once the total rainfall in the last hour drops below the Rain 1 Hour setting. This interrupt will prevent watering temporarily when rainfall is received.

Note: If a Weather Interrupt occurs, the Attention Indicator Light comes on and the cause of the interrupt is displayed on the Home screen. The date time and cause of the last interrupt is also recorded in the Information Log.

Note: Due to metric to English unit conversions, Weather Interrupts may not occur when the reported conditions appear to match Weather Interrupt settings. For example, a Temperature Interrupt may be set at 30° F and the current temperature displays 30° F, but the actual temperature may be 30.5° F. In this case, once the temperature drops below 30° F, the Weather Interrupt will occur.

4. Additional Settings and Options

Additional settings are programmed to facilitate general use of your ET Manager. From Settings in the Main Menu access:

- System Options
- Date and Time

System Options

Main Menu ► Settings ► Systems ► Options

There are four Options:

- Units
- Password
- Clear Data
- Defaults

Units

Main Menu ► Settings ► Systems ► Options
► Units

ET Manager can operate in either English units or metric units. To change navigate the menus to units, and use the **A** or **V** buttons to make the change.

Password

Main Menu ► Settings ► Systems ► Options
► Password

To limit access to the Settings menu a password may be set. To program a password, use **A** or **V** to select the desired numeric password. The value can be set from 1 to 255, or none. Once set, the password must be used to gain access to the Settings menus. A password setting of “None” disables password protection. None is found by scrolling one down from the numeric value 1.

Clear Data

Main Menu ► Settings ► Systems ► Options
► Clear Data

If it becomes necessary, you may clear all records stored in the ET Manager. Clearing Data will not change settings, but will erase all weather information, the current time and date, and will automatically set your Moisture Levels to 0, enabling watering.

To clear data, navigate the menus to the Clear Data screen, use the **V** to select “Yes.” Push the **►** button to confirm your decision.

Defaults

Main Menu ► Settings ► Systems ► Options
► Defaults

There are two options from the Defaults menu:

- Save Defaults
- Restore Defaults

Save Defaults

To save the current ET Manager settings as defaults, select Save Defaults then press **►**. You will then need to push **V** so the cursor is on “Yes” and push **►** to confirm your decision.



The defaults settings that can be saved are:

- Settings
 - Irrigation Control
 - Irrigation Amount and Landscape Adjustment % for Valve Group A and B
 - Water Window
 - Automatic
 - Daily
 - Available Watering Days
 - All, Odd, Odd with 31st Off, Even, Custom Days
 - Advanced Setting
 - Effective Rain Settings

3. Programming

- Maximum Hourly Rain
- Saturation Allowance A
- Saturation Allowance B
- Signal Crop Coefficient
- Wind Adjust %
- Historical ET
 - January - December
- System
 - Data Source
 - Weather Region
 - Rain Source
 - Elevation
 - Options
 - Units
 - Output Method
 - Enable
 - Enable A then B
 - ET and Rain Pulse
 - Rain and ET Pulse Duration
 - Pulse per minute
 - ET Pulse with Interrupt
 - ET Pulse Duration
 - Pulse per minute
- Weather Interrupt
 - Low Temperature
 - High Wind
 - Rain 24 Hour
 - Rain 1 Hour

Restore Defaults

To restore defaults, select Restore Defaults then press . You will then need to push  so the cursor is on "Yes." Push  to confirm your decision.

Date & Time

Main Menu ► Settings ► Date and Time

The Date and Time are updated from the weather signal sent by your WRSP. The only occasion you should need to program the date and time is in the event that no weather signal is available and the device is operating in the Historical ET Control Mode.

Year: Set the current year.

Month: Set the current month.

Day: Set the current day.

Time: Set the current time.

Programming the Sprinkler Controller

Your sprinkler controller will need to be programmed to work with your ET Manager. Specifically program:

- Watering Days
- Cycle Start Times
- Station Run Times
- Non-ET Based Watering Schedules

Note: Appendix VII, Sprinkler Controller Programming Worksheet, is available as a sprinkler controller programming aid.

Watering Days

The ET Manager controls the days of watering. Watering days will only occur as needed, based on weather information. The sprinkler controller should be programmed to water every day.

Note: If you choose to program the sprinkler controller with specific days off, then the ET Manager uses a sensor to detect a no water day and will continue to allow watering the next available day.

Cycle Start Times

Your ET Manager does NOT start a watering cycle; it “enables” or allows the sprinkler controller to activate the valves when watering is needed. Cycle start times should be programmed into your sprinkler controller to meet the needs of the site. You may program multiple start times into your sprinkler controller. The ET Manager will allow all cycles to operate.

Station Run Times

Station run times must be set in your sprinkler controller so the valves will apply the correct amount of water to your landscape. Your ET Manager “enables” watering cycles to refill the plant root zone by applying the Irrigation Amount. The station run times is the time it takes for sprinklers to apply the Irrigation Amount and is based on how fast the sprinklers apply water (precipitation rate). Table 1 can serve as a guide to determining station run times, given the precipitation rate and the Irrigation Amount.

Precipitation Rate (inches per hour)	Irrigation Amount (inches)			
	0.35"	0.50"	0.65"	
	Station Run Times (minutes)			
Typically Spray Heads {	2.00	11	15	20
	1.75	12	17	22
	1.50	14	20	26
	1.25	17	24	31
Typically Rotors {	1.00	21	30	39
	0.90	23	33	43
	0.80	26	38	49
	0.70	30	43	56
	0.60	35	50	65
	0.50	42	60	78
	0.40	53	75	98

Table 1. Minutes of Station Run Times

Refer to Appendix V for information on calculating the precipitation rate and station run times.

Note: Station run times may need to be adjusted based on the uniformity of the sprinkler system.

Note: The total station run time may need to be split into several cycles to allow the water to soak between cycles.

Non-ET Based Watering Schedules

If stations need to operate as programmed in the sprinkler controller, and NOT managed by your ET Manager, the ET Manager can allow a period of time for the sprinkler controller to water as programmed in the Daily Window; found in the Water Window submenu. Use a separate sprinkler controller program for non-ET based watering schedules.

4. System Check

Now that your ET Manager is installed and programmed, ensure successful operation by following the guidelines outlined in this chapter to verify that installation and programming is correct. To ensure the system check is completed properly, Refer to Appendix VIII: ET Manager Installation Checklist.

System Check

Verify these settings or tests after installation and programming are complete:

- Control Mode
- Weather Signal Test
- Valve Control Test
- Water Window Settings
- Initial Moisture Level

Control Mode

Main Menu ► Control Mode

There are three operating or Control Modes plus a temporary Override mode. The three Control Modes are:

- Automatic (normal operating mode)
- Historical ET
- Disabled

Automatic

Automatic control is the standard mode setting. In this mode all automatic functions are active and your ET Manager will operate as programmed. It will utilize the incoming weather signal to manage sprinkler control.

To set the ET Manager in Automatic mode, navigate the menus to the Control Mode screen.

A bullet • will be in front of the mode the ET Manager is currently set in. If the cursor ► is not in front of “Control Mode”, use ▲ or ▼ to move the location of

the cursor to Control Mode. Press ► to move the cursor location to the operating mode. Use ▲ or ▼ to position the cursor in front of “Automatic,” and press ◀ to move the cursor back to Control Mode. The • will be at “Automatic.”

Historical ET

When in Historical ET Control Mode, the ET Manager uses programmed daily ET averages for each month of the year to manage sprinkler control. In the Historical ET mode information from the weather signal is ignored. If an on-site rain gauge is installed with your ET Manager, the rain data recorded will adjust sprinkler control.

The Historical ET Control Mode is provided for 3 reasons:

1. In the event that the weather signal is temporarily not available, the ET Manager will operate based on Historical ET information as default backup.
2. There may be situations when you need a specific watering schedule. For example a seeded lawn may need daily watering. If needed, you can set the Control Mode to Historical ET and program the desired daily ET value.
3. Some locations may not currently receive a weather signal. An ET Manager can still be used to control sprinkler schedules based on Historical ET. Under these conditions an on-site rain gauge will provide improved real-time control of watering schedules.

Disabled

The ET Manager can be disabled. All automatic functions are suspended. The weather signal will continue to be received and logged, ET will be calculated, but all outputs are disabled and the Valve Group A and B Indicator Lights will go off. The ET Manager will not interrupt the sprinkler controller and the sprinkler system will operate as if the ET Manager was not there.

Note: If your ET Manager is set back to Automatic

mode after being in Disabled mode for an extended period of time, verify the current moisture level to determine when the first automatic watering cycle should occur.

Override

If you need to manually turn on valves and the ET Manager is interrupting the output of the sprinkler controller (Valve Group Indicator Light(s) are red), press the Override button to enable sprinkling for one hour. If more time is needed, press the Override button to increase override in one-hour increments.

The ET Manager can also be set to the Override mode from the Control Mode screen. Use **[▲]** in the Override Control Mode screen to set the number of hours the Override mode should run. After the override time has elapsed, your ET Manager will resume normal operation. If you want to cancel the Override mode, press **[▼]** until “Hours” is set to zero.

Weather Signal Test

The ET Manager uses a paging radio receiver with a built-in antenna to receive the weather signal. In most cases, this antenna is reliable.

Follow these steps to verify your ET Manager receives weather signals:

1. ET Manager must be powered using a 24-volt AC power source.
2. Navigate the menus to the Weather Signal screen.

Main Menu ► Information Log
► Weather Signal

3. Verify the weather signal is “Detected,” this may take up to two minutes.
4. From the Weather Signal screen, monitor the Test Counter. The Test Counter registers every signal received increasing from 1 to 255 counts.

Note: If 255 signals are received and counted, the Test Counter will reset to 0.

5. If the weather signal is “Not Detected” after two minutes, verify the Signal Provider Code is programmed correctly. If the Signal Provider Code is programmed incorrectly, use the **[▲]**, **[▼]** and **[▶]** buttons to set the codes for A through J.

Main Menu ► Settings ► System
► Data Source ► Signal Provider Code

Note: To obtain your Signal Provider Code, contact your WRSP, the Rain Bird Distributor, your installation contractor, or go to www.rainbird.com/etmanager. See chapter 3, Programming, for more information on the Signal Provider Code.

6. Once the Signal Provider Code is confirmed correct, press **[▶]** to reset.

Main Menu ► Information Log
► Weather Signal ► Reset

7. If the weather signal becomes “Detected,” monitor the signal Accuracy percentage over several days.

Main Menu ► Information Log
► Weather Signal ► Accuracy

8. If the signal remains “Not Detected” after completing the steps above, try a different installation location or an optional external antenna.

Note: Because of the nature of radio transmission, strength of the paging signal may vary depending upon your location. An external antenna may be used in some areas to eliminate signal weaknesses. See chapter 2, Installation, for more information on optional external antennas.

Note: The Reset command also clears the test counter.

4. System Check

Valve Control Test

When using Enable Output Method, your ET Manager controls the output of the sprinkler controller. Follow these steps to verify your ET Manager interrupts the stations on each Valve Group, A and B:

Note: To complete the Valve Control Test, the Automatic Window or Daily Window must be closed. If a status message appears on the Home screen with either “Automatic Window Open” or “Daily Window Open” temporarily close the Automatic or Daily Window by changing the Water Window settings outside the current time displayed on the Home screen.

1. On initial startup the Valve Group A and B Indicator Lights are green, indicating watering is not interrupted. If the lights are red, adjust the Current Moisture Level for A and B below zero.

Main Menu ► Irrigation Status ► A and B Moisture Level ► Current Level

2. Manually turn on each station with your sprinkler controller and visually check that all stations operate.
3. Adjust the Current Moisture Level for Valve Group A above zero. The Valve Group A Indicator Light will turn red and interrupt the watering on Valve Group A.

Main Menu ► Irrigation Status ► A and B Moisture Level ► Current Level

4. Manually turn on each station with your sprinkler controller and visually check that Valve Group A stations do not operate and Valve Group B stations still come on.
5. Reverse the Moisture Level settings for A and B, so that the Valve Group B Indicator Light is red and that the Valve Group A Indicator Light is green. Then repeat step 4 for to verify that

Valve Group B stations do not come on, while Valve Group A stations operate.

6. Set both Moisture Levels back to the desired level, a setting of zero will allow the next watering cycle to occur.

Water Window Settings

Verify the Water Window settings were set correctly in your ET Manager. The Water Window settings consist of the Automatic and Daily Windows, where the Automatic Window is the period of time that the ET Manager controls watering cycles based on ET and the Daily Window is an optional period of time when watering can occur as programmed in the sprinkler controller, and is not controlled by your ET Manager.

These Water Window settings should be checked to confirm that they correspond with the start times and run times programmed in the sprinkler controller. You should also verify that the current time is set correctly on the sprinkler controller.

Initial Moisture Levels

On startup, your ET Manager A and B Moisture Levels are “0.” At this level, watering will be allowed on the next cycle programmed in the sprinkler controller. If the amount of water in the soil is already high and the plants do not need immediate water, the initial moisture level for A and B can be increased to postpone watering.

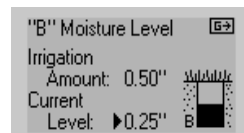
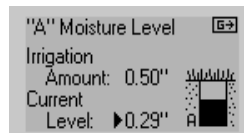

Use **▲** or **▼** to increase or decrease the Current Moisture Level for A or B.

5. Routine Operation

When installed and programmed properly, the ET Manager will automatically provide ET based management to your sprinkler system. In most cases, programmable settings should not need to be changed. Routine operation may include viewing and using:

- **Weather Information:** Current weather information is displayed. A two-week log of conditions is displayed graphically.
- **Irrigation Status:** Current moisture levels and irrigation settings are easily monitored.
- **Information Log:** Key events are recorded in the information log.
- **Override:** If manual watering is needed, press override to temporarily allow watering.
- **Status Messages:** The Home screen reports current activity.
- **Attention Messages:** If the Attention Indicator Light is on, the Status line will display important information.

Weather Information

Current weather information can be viewed in your ET Manager. The weather information is measured at a selected weather station and hourly data is broadcast in the weather signal to your ET Manager. The data is as current as the last broadcast. If a local rain gauge or rain region is used, rainfall amounts are recorded immediately. The following weather information can be viewed in the weather summary screen:

Main Menu ► Weather Info

- Rain
- Temperature
- Wind
- Humidity

Rain

Main Menu ► Weather Info ► Rain

The rain screen displays rainfall values measured by the selected rain source. The following detail is displayed:

- **Last Hour:** Total measured rainfall in the last hour.
- **Last 24 Hours:** Total measured rainfall in the last 24 hours.
- **Last 7 Days:** Total measured rainfall in the last 7 days.
- **Graph:** Press  to view a graph that represents the recorded rainfall over the last two weeks.

Temperature

Main Menu ► Weather Info ► Temperature

Temperature values included in the weather signal are recorded hourly averages. The following detail is displayed:

- **Current:** Hourly average air temperature from the latest recorded broadcast.
- **High Today:** The day's highest air temperature recorded broadcast since midnight.
- **Low Today:** The day's lowest air temperature recorded broadcast since midnight.
- **Graph:** Press  to view a graph that displays the recorded high and low temperatures over the last two weeks.

Wind

Main Menu ► Weather Info ► Wind

Wind values included in the weather signal are recorded hourly averages. Peak wind velocity is not displayed. The following detail is displayed:

- **Current:** Hourly average wind speed from the latest recorded broadcast.

5. Routine Operations

- **High Today:** The day's highest average wind speed recorded broadcast since midnight.
- **Low Today:** The day's lowest average wind speed recorded broadcast since midnight.
- **Graph:** Press  to view the graph. The graph displays the recorded average wind speed over the last two weeks.

Humidity

Main Menu ► Weather Info ► Humidity

Humidity values included in the weather signal are recorded hourly averages. The following detail is displayed:

- **Current:** Hourly average humidity percentage from the latest recorded broadcast.
- **High Today:** The day's highest humidity recorded broadcast since midnight.
- **Low Today:** The day's lowest humidity recorded broadcast since midnight.
- **Graph:** Press  to view a graph that represents the recorded humidity over the last two weeks.

Note: If no weather data has been stored in the ET Manager, each graph screen will be blank.

Irrigation Status

The most important information regarding the control of your sprinkler system can be seen in the two Moisture Level screens located in the Irrigation Status menu. In the Irrigation Status menu, ET, and rain information can also be viewed.

A (or B) Moisture Level

Moisture is depleted from the soil due to evaporation. Rain and water from the sprinkler system replaces this water. Your ET Manager uses this information to compute the current moisture level. When the Moisture Level reaches "0" watering is enabled and the sprinkler controller is allowed to water. Zero does not mean the soil is completely dry; zero means that the amount of water allowed to be depleted has evaporated and it is time to water.

There are three factors used to compute the Current Moisture Level:

- **ET:** Water evaporates and transpires from the landscape based on current weather conditions.
- **Effective Rain:** Rain is measured using the selected rain source. Accepted rainfall is limited by the Effective Rain settings.
- **Irrigation:** Watering from your sprinkler system.

The formula to calculate the Current Moisture Level is:

Current Moisture Level = Last Moisture Level – ET + Effective Rain + Irrigation, where:

- **Last Moisture Level** = Moisture Level from the prior hour
- **ET** = ET measurements adjusted by the Landscape Adjustment percentage
- **Effective Rain** = Limited due to programmed Max Hourly Rain and Saturation Allowance
- **Irrigation** = Irrigation Amount setting once watering is detected

Table 2 represents an example of how the moisture level can change over time. Notice that on the day the Moisture Level reaches “0,” irrigation occurs to refill the soil.

Date	ET	Effective Rain	Irrigation	Soil Moisture Level
6/1/04	0.16			0.23
6/2/04	0.05	0.20		0.38
6/3/04	0.09	0.26		0.55
6/4/04	0.11	0.14		0.58
6/5/04	0.18			0.39
6/6/04	0.14	0.01		0.26
6/7/04	0.07	0.12		0.31
6/8/04	0.11	0.02		0.22
6/9/04	0.18			0.03
6/10/04	0.20	0.04		0.23
6/11/04	0.09	0.03		0.16
6/12/04	0.18		0.50	0.48
6/13/04	0.18			0.30
6/14/04	0.19			0.11
6/15/04	0.08			0.03
6/16/04	0.20		0.50	0.33
6/17/04	0.20			0.13
6/18/04	0.08	0.05		0.09
6/19/04	0.04	0.44		0.50
6/20/04	0.12			0.37
6/21/04	0.19			0.18
6/22/04	0.18		0.50	0.50
6/23/04	0.07			0.43
6/24/04	0.21			0.22
6/25/04	0.10			0.12
6/26/04	0.11	0.06		0.08
6/27/04	0.06	0.33		0.35
6/28/04	0.19			0.16
6/29/04	0.16		0.50	0.50
6/30/04	0.10	0.09		0.49

Table 2. Moisture Level Chart

Table 2 demonstrates that ET causes water to be lost from the soil moisture level. It is subtracted from the prior soil moisture level and effective rain or sprinkling adds to the soil moisture level.

6/1/2004 Soil Moisture Level = 0.23”
 6/2/2004 - ET = 0.05”
 0.18”
 + Effective Rain = 0.20” (Rain delays watering)
 6/2/2004 Soil Moisture Level = 0.38”

Once daily accumulation of ET causes the soil moisture balance to reach zero or a less than zero balance (negative balance), the ET Manager will allow sprinkling to occur.

6/11/2004 Soil Moisture Level = 0.16”
 6/12/2004 - ET = 0.18”
 -0.02”
 + Irrigation = 0.50” (Watering occurs)
 6/12/2004 Soil Moisture Level = 0.48”

This same information can be displayed graphically in Figure 11.

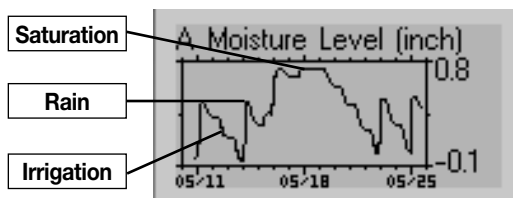

Figure 11. Soil Moisture Level

To keep plants healthy, proper landscape water management will keep soil moisture at optimum levels. Saturated soil starves the roots of essential oxygen. The soil must be allowed to dry out, not to a wilt point, but enough to get air to the roots. To promote a deep healthy root system, best horticultural practices recommend deep, less frequent watering. Watering frequency should be managed in response to changing weather conditions and rainfall. The ET Manager monitors evaporation and manages your sprinkler system allowing watering only when needed.



5. Routine Operations

Access Moisture Levels for A or B

Main Menu ► Irrigation Status
► A (or B) Moisture Level

The following information is shown on this screen:

- **Irrigation Amount:** The amount of water applied by the sprinkler system to refill the soil moisture reservoir.
- **Current Level:** The current calculated moisture level for A (or B).
- **Moisture Level Graphic:** On the right the graphic represents the current moisture level. When the “soil” is “empty” it is time to water. Watering is not needed until the Moisture level reaches zero.
- **Graph:** Press  to display a graph that represents the soil moisture level over the last two weeks.

Adjusting the Current Level: There may be circumstances when the current level needs to be adjusted, like during Valve Group testing, delaying watering, or troubleshooting. Use  or  to make the change. Increasing this value may delay watering. By taking the value to zero watering will be allowed on the next scheduled cycle.

Rain

Main Menu ► Weather Info ► Rain

The rain screen displays rainfall values measured from the selected rain source. The ET Manager stores fourteen days of information, which can be viewed in the graph. The following detail is displayed:

- **Last Hour:** Total measured rainfall in the last hour recorded broadcast.
- **Last 24 Hours:** Total measured rainfall in the last 24 hours.
- **Last 7 Days:** Total measured rainfall in the last 7 days.
- **Graph:** Press  to view the rain graph for the last two weeks.

Evaporation (ET)

Main Menu ► Irrigation Status ► ET

The ET screen displays the ET calculated by the ET Manager based on current settings and the weather conditions included in the weather signal. The ET Manager stores fourteen days of information, which can be viewed in the graph. The following detail is displayed:

- **Last Hour:** ET based on data in the last hour recorded broadcast.
- **Last 24 Hours:** Total ET in the last 24 hours.
- **Last 7 Days:** Total ET in the last 7 days.
- **Signal Kc:** Signal crop coefficient percentage included in the weather signal.
- **Graph:** Press  to view the ET graph for the last two weeks.

Note: In the Automatic Control Mode, when weather signals are missed the ET Manager will automatically calculate ET for the missed signals. If weather signals are not received for more than a day then the ET Manager will calculate ET based on weather data from the last 7 days. If there is no weather signal received for more than a week, the mode automatically uses the pre-programmed Historical ET values. Even though signals are missed, the ET Manager will continue to operate. When this occurs, the ET Manager will report the last hour of ET as 0.00".

Note: In the Historical Control Mode, the ET Manager will report the last hour of ET as 0.00".

Information Log

The Information Log menu helps you know what events have occurred. Watering over the season is recorded, weather interrupts, and signal status can help you monitor the activity of your ET Manager. The Information Log includes:

- A Irrigation Log
- B Irrigation Log
- Last Interrupt
- Weather Signal

A or B Irrigation Log

Main Menu ► Information Log

► A (or B) Irrigation Log

- **Last:** Date and time of the last detected Automatic Window watering for Valve Group “A” or “B.”
- **Days Watered:** Number of days the ET Manager has allowed watering for Valve Group “A” or “B.” This accumulates “since” the date indicated on this screen.
- **Total Water:** The estimated total amount of watering for Valve Group “A” or “B.” This accumulates “since” the date indicated on this screen.
- **Since:** The Days Watered and Total Inches of water applied are calculated since the date indicated.
- **Graph:** With the ► cursor pointing to the Graph icon, press ► to view the two-week soil moisture graph.
- **Clear:** Position the ► cursor to the Clear option to reset the “Since” date. This will also reset the Days Watered and Total Water to zero. Clearing will also reset the since date to the current date.

Last Interrupt

Main Menu ► Information Log ► Last Interrupt

The Last Interrupt displays the cause, date, and time of the last weather interrupt.

Weather Signal

Main Menu ► Information Log ► Weather Signal

The Weather Signal screen displays:

- **Last:** The date and time of the last recorded weather signal.
- **Accuracy:** The ET Manager looks at the last two weeks of weather signals and reports the

accuracy of the weather signal. An accuracy level less than 65% will create an Attention condition. The cause should be identified and corrected. If a weather signal is missed the ET Manager adjusts automatically.

- **Signal:** The weather signal is reported as either “Detected” or “Not Detected.” If the weather signal is not detected press the ► at the Reset option to confirm this status. Signal detection can take up to two minutes. If this condition persists contact your installer or Rain Bird Authorized Distributor.
- **Test Counter:** The test counter reports all signals received by the ET Manager. The frequency and number of signals is controlled by the WRSP. The test counter is a diagnostic tool to further test the signal reception of the ET Manager. The test counter accumulates signals, and is cleared by resetting the signal. The Test Counter registers every signal received increasing from 1 to 255 counts, and resets to zero once 255 is reached.

Status Messages

During normal operation the ET Manager is performing programmed functions. There are conditions that your ET Manager reports. On the Home screen the second line displays current status messages. When more than one message needs to be displayed the messages will alternate every few seconds.

Note: “Attention” messages are also displayed on the same Home screen line.

The following is an explanation of the status messages displayed:

- Automatic Window Open
- Daily Window Open
- Disabled Mode
- No Water Day
- Hour Manual Override
- No Power

5. Routine Operations

Automatic Window Open

The Automatic Window is a period of time programmed in your ET Manager corresponding to the time period the sprinkler controller is programmed to water with ET-based control. When the Automatic Window “opens,” it looks at the current moisture balance and Irrigation Amounts and determines if watering is needed for Valve Groups A and/or B. Once the Automatic Window “opens,” it remains “open” for the entire period. Watering is either interrupted or enabled the entire time. Changes to the moisture level during this period will not affect the “decision” to interrupt or enable watering. Those changes will affect the next Automatic Window period.

Daily Window Open

The Daily Window is a period of time programmed in your ET Manager corresponding to the time period the sprinkler controller is programmed to water BUT NOT based on ET control. Watering is allowed every day during the Daily Window. When the Daily Window “opens” it enables or allows watering on both Valve Groups A and B. The Daily Window period operates outside the Automatic Window.

Disabled Mode

When the ET Manager is disabled all automatic functions are suspended. The ET Manager will not interrupt the sprinkler controller; it will operate as if the ET Manager was not there. The normal operating mode is Automatic.

No Water Day

Available watering days can be programmed in your ET Manager. If the current day has been set to “Off,” watering will not be *enabled* regardless of the current Moisture Levels. The No Water Day status message indicates if the current day has been set to “Off.”

Hour Manual Override

Your ET Manager can be temporarily “Overridden” to allow manual watering. Pressing the Override button once starts a one-hour override. Each time the Override is pressed one more hour is added to the Override mode. The status display indicates when an

Override has been started and the amount of time left before it reverts back to the normal operating mode.

No Power

The ET Manager needs power to operate. The battery is used only to keep time during a power outage and keep the display screen active. If there is no power, a No Power message will appear. Restore power to your ET Manager. If power has been off for a week, the battery should be replaced.

Attention Messages

If the Attention Indicator Light turns yellow there is a condition that you should be aware of. An Attention condition indicates that normal functions have been interrupted. On the Home screen, the second line displays a message indicating the condition. When more than one message needs to be displayed, the messages will alternate every few seconds.

Note: Status messages are also displayed on the same Home screen line.

The following Attention conditions are displayed when each condition is detected by your ET Manager:

- Temperature Interrupt
- Wind Interrupt
- 24 Hour Rain Interrupt
- 1 Hour Rain Interrupt
- Provider Interrupt
- No Signal Service
- No Weather Data
- No Paging Signal
- Signal Accuracy
- No Historical ET Data
- Decoder Failure
- No Watering Detected
- Rain Tip Input Failure
- Set Signal Provider Code
- Window Overlaps Off Day

Temperature Interrupt

If the last weather signal temperature record is at or below the Temperature Interrupt setting, a Weather Interrupt will occur.

Action to take: The Weather Interrupt is cancelled once the air temperature rises above the programmed interrupt setting received in the hourly weather signal; your ET Manager will continue normal operation. If water was interrupted, you may want to manually water affected stations.

Wind Interrupt

If the last weather signal wind record is at or above the Wind Interrupt setting, a Weather Interrupt will occur.

Action to take: The Weather Interrupt is cancelled once the wind speed lowers below the programmed interrupt setting received in the hourly weather signal; your ET Manager will continue normal operation. If watering was interrupted, you may want to manually water affected stations.

24 Hours Rain Interrupt

Rainfall over the last 24 hours that is at or above the 24 Hour Rain Interrupt setting will cause a Weather Interrupt. The Weather Interrupt is cancelled because the total rainfall in the last 24 hours dropped the Rain 24 Hour setting.

Action to take: Once the rainfall recorded in the last 24 hours drops below the 24 Hour Rain Interrupt setting, your the ET Manager will continue normal operation. You may want to manually water affected stations.

1 Hour Rain Interrupt

Rainfall over the last hour that is at or above the 1 Hour Rain Interrupt setting will cause a rain interrupt. The Weather Interrupt is cancelled once the total rainfall in the last hour drops below the Rain 1 Hour setting.

Action to take: Once the rainfall recorded in the next hour(s) drops below the 1 Hour Rain Interrupt setting,

the ET Manager will continue normal operation. You may want to manually water affected stations.

Provider Interrupt

The WRSP can send a signal to interrupt watering. This may be done for an emergency condition in the community requiring watering to be suspended to limit demand on the community water system. As a service your WRSP may also watch weather forecasts and choose to interrupt watering. A Provider Interrupt lasts for 24 hours.

Action to take: If you want to know why the Provider Interrupt has occurred, contact your WRSP to determine the cause of the Provider Interrupt.

Note: If you need to water during a Provider Interrupt, a manual override will allow you to do so.

No Signal Service

Your WRSP can send a “No Signal Service” signal to cancel weather signal reception. Typically this would happen only if the terms of the service agreement were not met. If signal service is canceled, your ET Manager will continue to operate using programmed averaged daily ET from the Historical ET settings.

Action to take: Contact your WRSP to determine the cause of “No Signal Service.” Your WRSP can also send a signal to restore service.

No Weather Data

If your ET Manager has not received a weather signal for more than 24 hours, the Attention Indicator Light comes on and this message is displayed. There could be three causes for this condition:

- Your ET Manager Weather Region setting is not programmed correctly
- Your WRSP is not broadcasting the weather signal
- Radio frequency issues are preventing your ET Manager from receiving weather signals

5. Routine Operations

Actions to take:

1. Check when the last weather signal was received by your ET Manager.



Main Menu ► Information Log
► Weather Signal

2. Check the Accuracy percentage of the weather signal.

Main Menu ► Information Log ► Weather Signal

3. Verify the weather region in your ET Manager is programmed correctly. Navigate the menus to the Data Source screen to view the programmed weather region.

Main Menu ► Settings ► System
► Data Source ► Weather Region

4. If the Weather Region number is programmed incorrectly, press  to move the cursor location to the number and use the  or  to change the weather region number.

5. If you continue to have the No Weather Data message, contact your WRSP or call Rain Bird Technical Services at 1-877-351-6588 to verify that no weather data is being sent.

Note: In the Automatic Control Mode, when weather signals are missed the ET Manager will automatically calculate ET for the missed signals. Even though signals are missed, the ET Manager will continue to operate. If weather signals are not received for more than a day then the ET Manager will calculate ET based on weather data from the last 7 days. If there is no weather signal received for more than a week, the mode automatically uses the pre-programmed Historical ET values.

No Paging Signal

Your ET Manager is programmed to a specific Signal Provider Code to receive the weather signal. Commercial wireless paging systems carry the wireless weather signal. The ET Manager regularly verifies the presence of the weather signal. If the weather signal is not detected after a period of time the Attention Indicator Light comes on and the “No Paging Signal” is displayed.



Actions to take: If this Attention condition occurs, wait two minutes to ensure the weather signal will not be detected within the next few minutes. If the Attention message remains, follow these steps:

1. Navigate the menus to the Weather Signal screen.

Main Menu ► Information Log
► Weather Signal

2. Press  to reset the pager.

Main Menu ► Information Log
► Weather Signal ► Reset

3. Monitor the Accuracy percentage and the Test Counter. Should these values increase, the paging signal may have been restored.
4. If the Signal changes from “Not Detected” to “Detected,” your paging signal is restored. If it remains “Not Detected,” continue to step 5.
5. Verify the Signal Provider Code is programmed correctly. If the Signal Provider Code is programmed incorrectly, use the , , and  buttons to set the codes for A through J.

Main Menu ► Settings ► System
► Data Source ► Signal Provider Code

Note: To obtain your Signal Provider Code, contact your WRSP, the Rain Bird Distributor, your installation contractor, or go to www.rainbird.com/etmanager. Refer to chapter 3, Programming, for more information on the Signal Provider Code setting.

6. If the weather signal becomes “Detected,” the “No Paging Signal” message will discontinue. Monitor the signal Accuracy percentage for several days.
7. If the signal remains “Not Detected” after completing the steps above, try a different installation location or an optional external antenna.

Note: Because of the nature of radio transmission, strength of the paging signal may vary depending upon your location. An external antenna may be used in some areas to eliminate signal weaknesses, see chapter 2, Installation, for more information on optional external antennas.

Note: The Reset command also clears the test counter.

Note: In the Automatic Control Mode, when weather signals are missed the ET Manager will automatically calculate ET for the missed signals. Even though signals are missed, the ET Manager will continue to operate using stored ET and Historical ET values.

Signal Accuracy

Your ET Manager checks and stores data received in the weather signal. If data reception accuracy is less than 65% then the “X% of Signal Accuracy” Attention message will come on. For example with a signal accuracy of 58%, the Home screen will display “58% of Signal Accuracy.”

In the Automatic Control Mode, when weather signals are missed the ET Manager will automatically calculate ET for the missed signals. Even though signals are missed, the ET Manager will continue to operate. If weather signals are not received for more than a day then the ET Manager will calculate ET based on weather data from the last 7 days. If there is no weather signal received for more than a week then the mode automatically uses the pre-programmed Historical ET values.

The proper action to take when the signal accuracy is less than 65% depends on duration. If your ET Manager has missed data for a few days and the signal

accuracy becomes low, there may not be a significant problem with your ET Manager or the weather signal. However, if your ET Manager has missed data for two weeks or more, it is likely there is a problem in need of fixing.

Actions to take: Low Accuracy percentages can result from several conditions:

1. If power is off for a period of time the weather signal is not received. When power is restored your ET Manager determines that messages have been missed. Over time the Accuracy percentage will increase and the Attention Indicator Light will go off.

Main Menu ► Information Log
► Weather Signal ► Accuracy

2. Weak radio reception or radio interference may cause missed weather signals. An external antenna may be needed to improve radio reception. Contact Rain Bird to find out more information about an optional external antenna, refer to chapter 2, Installation.
3. It may be that your WRSP had system problems that interrupted the weather signal for a period of time. If data continues to be missed for several days, contact your WRSP, to check if there has been interruption in the weather signal.
4. Occasionally, the paging system may malfunction. If data continues to be missed for several days, contact your WRSP to see if they are aware of any problems.

Note: All missed messages are replaced with a calculated ET value based on previously received weather information and the historical ET programmed in your ET Manager.

No Historical ET Data

Your ET Manager uses a historical ET database as a backup in the event weather signal service is not available. During programming, the Historical ET Database was set based on local conditions. If this was not programmed, a “No Historical ET” message is displayed.

Action to take: Monthly historical ET values for your area are available from the Historical ET database included in the ET Manager Scheduler program on the Resource CD. Look up your city and state, and program the monthly values into your ET Manager.

Main Menu ► Settings ► Irrigation Control
► Advanced Settings ► Historical ET

Decoder Failure

Your ET Manager uses signal decoder to receive the weather signal. The Attention Light will come on and “Decoder Failure” will appear if your ET Manager is experiencing decoder problems.

Action to take: The decoder may need to be reinitialized. To do so, disconnect power from your ET Manager, and then restore power. If the problem persists, return your ET Manager for repair.

No Watering Detected

If your ET Manager has not been properly wired, or the sprinkler controller has not been properly programmed, your ET Manager may not detect watering. “No Watering Detected” appears on the Home screen and the Attention Light will come on when this condition occurs.

Note: If this condition continues, your landscape could reach a damaging stress level. Current Moisture Level(s) will reach a maximum dryness.

Action to Take:

1. Verify your sprinkler controller is turned on to allow watering.
2. Verify that the current time is set correctly on the sprinkler controller.

Main Menu ► Settings ► Irrigation Control
► Water Window

3. Verify the Automatic Window setting is set correctly in your ET Manager and synchronized with your sprinkler controller. Water Window settings should be checked to confirm that they correspond with the start times and run times programmed in the sprinkler controller.
4. Complete the Valve Control Test in Operation Verification, chapter 4, to ensure Valve Groups A and B are controlled by your ET Manager.
5. You may want to manually water affected stations.

Note: If you have restricted the available watering days in your sprinkler controller, you may experience a No Water Day.

Rain Tip Input Failure

Your ET Manager can use real-time rain data collected from an optional on-site rain gauge. If you are using a rain gauge to collect rain data and “Rain Tip Input Failure” appears on the Home screen, your ET Manager is indicating a problem with the Rain Tip wire terminal, installation, or operation of the on-site rain gauge.

Action to Take:

1. Verify the on-site rain gauge is installed and wired properly; refer to chapter 2, Installation, Optional Rain Gauge.
2. Check the length of the rain gauge wire for cuts or nicks, and replace damaged wire.
3. Check the rain gauge for damage.

Set Signal Provider Code

If the attention message, “Set Signal Provider Code” appears on the Home screen, your ET Manager has been installed, but not programmed with the appropriate Signal Provider Code.

Action to Take: Navigate the menus to Signal Provider Code and program the appropriate Signal Provider Code.

Main Menu ► Settings ► System ► Data Source
► Signal Provider Code

Use the **A**, **V** and **▶** buttons to set the codes for A through J.

Note: To obtain your Signal Provider Code, contact your Rain Bird Distributor, your installation contractor, or go to www.rainbird.com/etmanager. Refer to chapter 3, Programming, for more information regarding the Signal Provider Code.

Window Overlaps Off Day

If the attention message “Window overlaps off day” appears on the Home screen, the Water Window programmed in your ET Manager is overlapping a restricted watering day. When restricting available watering days, the Water Window must begin and end either before midnight, or after midnight. If your Water Window is programmed to run through midnight, you must set available days to all in the ET Manager. You can still program off days by turning days off on your sprinkler controller. A sensor built into your ET Manager will recognize off days scheduled into your sprinkler controller. The Look-Ahead Feature will not function.

Action to take: Navigate the menus to Water Window and change the Water Window to begin and end either before or after midnight.

Main Menu ► Settings ► Irrigation Control
► Water Window

Note: If this situation occurs, and your Water Window is “open” and the sprinkler system is watering on an “on” day and the next day is an “off” day, watering will cease at midnight.

6. Determining Programmable Settings

As a smart control system, your ET Manager and sprinkler system will work together to keep your landscape healthy. Programmable settings are site specific. Performing an accurate site assessment and using the information gathered to program your ET Manager ensures the efficiency of your smart control system.

This chapter will walk you through the process of conducting a site assessment. The site assessment will give you key information about your sprinkler system and landscape conditions needed to program settings in your ET Manager and sprinkler controller.

Site Assessment

By conducting a site assessment, you will determine:

- Sprinkler Controller and Station Information
- Landscape Conditions

Use the Site Assessment Worksheet, Appendix III, to help complete the site assessment. Please refer to Figure 12 to view an example of information collected during a site assessment.



ET Manager Site Assessment Worksheet

Site Name: Jones Residence			Date: 08-Sep-05					
Address: 538 Picket Fence, Anywhere, USA								
Sprinkler Controller Type: Rain Bird ESP 12LX								
ET Manager Installation Location: Garage			<input type="checkbox"/> Outdoor Enclosure					
Sprinkler Controller Station Information								
Station	Description	Valve Group	Sprinkler Type & Precipitation Rate (or Spacing, Nozzle, PSI, Radius, GPM)	Exposure	Slope			
					0-3%	4-6%	7-12%	13% +
1	North side of home	<input checked="" type="checkbox"/> A <input type="checkbox"/> B <input type="checkbox"/> None	MPR pop up, 15 ft, 1.2 in/hr, MPR 5Q, 30 psi, 0.92 gpm	Not in sun all day	<input checked="" type="checkbox"/>			
2	South side of home	<input type="checkbox"/> A <input checked="" type="checkbox"/> B <input type="checkbox"/> None	MPR pop up, 10 ft, 1.0 in/hr, MPR 5F/5H, 30 psi, 0.2-0.4 gpm	Sun most of day	<input checked="" type="checkbox"/>			
Landscape Conditions								
Valve Group:	Plant Type:		Soil Type:		Root Depth (in):			
A	Kentucky Bluegrass		Clay loam		4			
B	Variety of Shrubs		Clay loam		8			
Rain Bird Technical Service: 1-877-351-6588								

Figure 12. Site Assessment Worksheet Example

Sprinkler Controller and Station Information

The sprinkler system delivers water to the landscape refilling the soil reservoir. To use an ET Manager, the site must have an operating sprinkling system complete with automatic valves controlled by a sprinkler controller. The sprinkler system capabilities affect how to program your sprinkler controller and your ET Manager. Refer to chapter 4, Programming, for more detail on programming your sprinkler controller.

Sprinkler Controller Type

An ET Manager is compatible with almost all sprinkler controllers including basic non-ET controllers and advanced ET-based controller systems. The sprinkler controller type must be determined upon installation to decide the Output Method used with your ET Manager.

Non-ET based sprinkler controllers are installed and programmed to the Enable Output Method (see “Output Method” below). ET-based sprinkler controllers are installed and programmed to an advanced Output Method. Refer to chapter 8, Advanced Output Methods, to determine which method is appropriate for your ET-based sprinkler controller.

Station

Stations on a sprinkler controller are connected to specific valves that are activated according to your ET Manager. Each station should have plants with similar water requirements within its area. Stations are also referred to as “zones.” Stations must be assigned to specific ET Manager Valve Groups A, B, or none.

Note: When a station has a wide variety of water requirements within its area, it becomes necessary to water according to the area in the station that needs the most water to keep plants healthy.

Description

The station description can include information that describes the on-site location of the station and the condition of the landscape in the station at the time of the site assessment.

Valve Group Assignment

Your ET Manager supports two valve groups. For example, Valve Group A may be assigned to lawn stations and Valve Group B may be assigned to shrub stations. Determine how the Valve Groups are to be assigned to each station.

To use both Valve Groups A and B with your sprinkling system, the common wire to A valves must be separate from the common wire to B valves. While the sprinkler system is being installed two common wires must be used; one to Valve Group A and one to Valve Group B. When retrofitting an existing system, a spare wire can be used for the common on one of the valve groups.

Sprinkler Type and Precipitation Rate

Sprinkler systems are a complex arrangement of sprinkler heads, valves, and piping. Sprinkler type, layout, nozzle size, and water pressure affect the rate water is applied by the sprinklers. The rate at which water is applied to the landscape or the precipitation rate is measured in inches per hour.

The precipitation rate is needed to determine the station run times, or how long the valves should run to deliver the programmed ET Manager Irrigation Amounts. For example, if the Irrigation Amount is 0.5 inches and the station sprinklers apply 1.50 inches of water per hour, it would take 20 minutes to apply the Irrigation Amount (0.50 inches). Refer to Appendix V for more information on calculating precipitation rates and station run times.

Sprinkler systems apply water with varying degrees of uniformity or efficiency. Station run times may need to be increased to compensate weaknesses in sprinkler coverage.

Exposure

When assessing a site it is important to observe conditions, such as environmental exposures. Sun exposure and high wind exposure increase the rate of evaporation. By understanding the exposures, you can make better water scheduling decisions. Exposure areas that would increase the rate of evaporation may need longer

6. Determining Programmable Settings

station run times, while exposure areas that would decrease the rate of evaporation may be fine with shorter station run times.

Slope

When sprinklers apply water faster than the soil can absorb, water can run-off. Sloping landscapes increases the chance of run-off occurring. Frequent watering cycles programmed in the sprinkler controller can minimize this problem. The ET Manager will allow the sprinkler controller to operate multiple watering cycles to prevent run-off. This method of watering, often referred to as cycle and soak, is preferred because it prevents run off.

Landscape Conditions

Landscape conditions determine how much and how often your landscape should be watered. Three landscape factors, plant type, soil type, and root depth, are essential in a site assessment. Using these factors you can accurately program your ET Manager to your specific landscape needs.

Plant Type

Plants need water to transport nutrients for cell development and temperature control. Different plant types respond to changing environmental conditions in different ways. For example, cool season grasses respond to high evaporation rates by going into dormancy during the hottest days of the year. Other plants like shrubs tend to have deeper roots and can sustain higher evaporation than grass by accessing water deeper in the soil.

It is important to understand what plant types are included in the landscape. As stated previously Valve Group A is typically assigned to lawn stations and Valve Group B is typically assigned to shrub stations. These different plant types use water at different rates requiring different Irrigation Amounts and Landscape Adjustment Percentages.

Soil Type

Soil is a habitat for soil organisms and plant roots. It functions as a storehouse for nutrients and a water reservoir. It contains and supplies water, oxygen, nutrients, and provides mechanical support for plant growth.

Soil type and root depth largely determine the amount of water that can be stored in the soil. There are several ways to determine soil type, i.e. sand, loam, clay, etc. A laboratory soil test can provide exact information. Soil type can be determined by a simple feel test; see Appendix IV for the diagram.

Root Depth

Plant roots draw water from the soil. Deeper roots increase the availability of water for the plants because plants with deep roots can access water at greater soil depths, see Figure 13. Use a shovel or soil probe to determine your plant root depth.

Note: During plant establishment, the plant root depth increases. Because roots will grow deeper during establishment, the Irrigation Amount will need to be increased accordingly. The result will be to water less frequently, as the plant roots grow deeper.

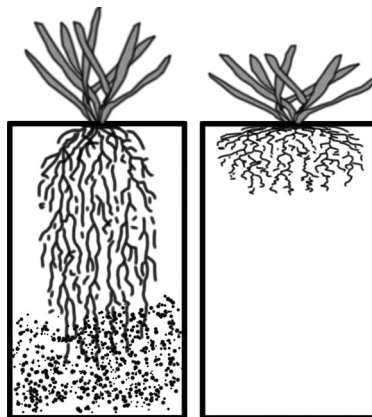

**Figure 13. Deep Roots
vs. Shallow Roots**

ET Manager Settings

Information gathered in your site assessment should be used to determine your programmable ET Manager settings. The ET Manager settings consist of:

- Irrigation Control Settings
- Advanced Settings
- System Settings

Use your ET Manager Site Assessment Worksheet, Appendix III, and the ET Manager Settings Worksheet, Appendix VI, to program your ET Manager.

Irrigation Control

Soil type and rooting depth limit how much water the soil can hold for the plants, and how much water the plants can use. The type of plants used in the landscape affect evaporation rates. Together these factors affect how often the landscape needs water. By evaluating landscape conditions, you will be prepared to enter accurate settings in your ET Manager.

Landscape conditions affect the following programmable settings:

- Irrigation Amount for Valve Groups A and B
- Landscape Adjustment % for Valve Groups A and B

Irrigation Amount

The Irrigation Amount represents how many inches (or mm) of water is applied to your landscape during each watering cycle. This amount of water evaporates before the ET Manager will allow watering to occur. The amount is based on your soil type and the plant's root depth (refer to Table 3). Because your landscape may have different types of plants, your ET Manager has two Irrigation Amount settings; one for valves in Valve Group A and another for valves in Valve Group B.

Soil Type	Irrigation Amount					
	Estimated Irrigation Amount (inches)					
	Root Depth (inches)					
	2	4	6	8	12	18
Sand	0.02	0.05	0.07	0.10	0.14	0.22
Fine Sand	0.07	0.14	0.22	0.29	0.43	0.65
Loamy Sand	0.08	0.17	0.25	0.34	0.50	0.76
Sandy Loam	0.12	0.24	0.36	0.48	0.72	1.08
Loam	0.17	0.34	0.51	0.68	1.02	1.53
Sandy Clay Loam	0.15	0.30	0.45	0.60	0.90	1.35
Silty Loam	0.20	0.40	0.60	0.80	1.20	1.80
Clay Loam	0.20	0.40	0.60	0.80	1.20	1.80
Silt	0.17	2.34	0.51	0.68	1.02	1.53
Silty Clay Loam	0.20	0.40	0.60	0.80	1.20	1.80
Silty Clay	0.13	0.26	0.38	0.51	0.77	1.15
Clay	0.09	0.18	0.27	0.36	0.54	0.81

Table 3. Irrigation Amount Chart

Note: The Irrigation Amount depends on soil composition, compaction, chemistry, temperature and plant characteristics, etc. The above values are estimates, and can be used as a basis for determining irrigation schedules. If conditions change, the Irrigation Amount should be adjusted.

When retrofitting your ET Manager to an existing system, an effective Irrigation Amount setting can be estimated based on previous watering habits. Determine the average daily ET during the peak of the year. Determine how frequently you watered during this period, and how long the station run times were. Take the peak ET rate and multiply it by the frequency of watering. For example, if your average peak ET is 0.25 inches and you watered every other day, you would take 0.25 and multiply by 2. Your estimated Irrigation Amount is 0.5 inches. Make sure that the run times scheduled in the sprinkler controller match those you used previously during the peak of the year.

Landscape Adjustment Percentage (%)

ET is calculated with a short grass reference crop grown in an "ideal" environment. Specific plant water needs will vary depending on the type of plants and landscape conditions. The Landscape Adjustment Percentage is used to fine-tune how much irrigation water a landscape should receive. There are three factors that should be considered when estimating the Landscape Adjustment Percentage:

6. Determining Programmable Settings

- Plant Species
- Planting Density
- Microclimate

As general rule the Landscape Adjustment Percentages should range between 70% to 100% for turf grass and 50% to 80% for shrubs.

Note: Additional station-by-station adjustments can also be made in the sprinkler controller. Once your ET Manager is installed, the system should be monitored and these settings may need to be changed.

Note: The Weather Reach Signal Provider (WRSP) can include in the weather signal a crop coefficient (Kc) value. This is done as a service to the end user because the Kc value can change over the course of the season. Check with the WRSP to see if regional Kc value is being used. If it is being used, the Landscape Adjustment Percentage should be set based on recognizing this regional service.

Example: If a WRSP is sending a seasonal Kc value, it is typically based on the predominate turf grass in the area. In this case, Landscape Adjustment Percentage would normally be left at 100% for turf schedules. The Landscape Adjustment Percentage for shrub schedules should be adjusted based on the Kc value already being applied to ET. For example, if the broadcast Kc value was 80% at mid season and a shrub Landscape Adjustment Percentage of 50% was needed then the Landscape Adjustment Percentage should be set at 62% ($50\% / 80\% = 62\%$).

Water Window

The ET Manager Water Window needs to be synchronized with the start and run times programmed in your sprinkler controller. There are two Water Windows used to manage the system:

- **Automatic Window:** The period of time that the ET Manager controls watering cycles based on ET.
- **Daily Window:** An optional period when watering can occur as programmed in the

sprinkler controller, and not controlled by the ET Manager.

Automatic Window

The Automatic Window is a period of time based on the first start time programmed in the sprinkler controller and the amount of time it takes to complete all watering cycles controlled by ET. When Valve Groups A or B are enabled, watering is allowed during the Automatic Window.

At the opening of the Automatic Window, the ET Manager determines if watering should occur. If watering is needed the Valve Group Indicator Light for A or B will be green and watering is enabled, allowing the sprinkler controller to activate valves. It remains enabled through the duration of the Automatic Window. If the Moisture Level for the valve group has not reached zero, the Valve Group A or B Indicator Light remains red and watering is suspended through the Automatic Window period.

When watering is enabled in a valve group and the sprinkler controller activates the valves, the ET Manager uses a built-in electrical sensor to verify that watering occurred. If watering is not detected during the Automatic Window, watering remains enabled through the next day's Automatic Window.

Daily Window

If there are stations that require non-ET based management they can be programmed in the sprinkler controller to water as needed using the Daily Window. These stations must be programmed in the sprinkler controller to water during a period outside the Automatic Window period. Stations programmed in the sprinkler controller can be set to water any day, but the watering time must occur within the Daily Window period.

The Daily Window will allow watering every day scheduled in the sprinkler controller. When the Daily Window opens, both the Valve Group A and Valve Group B Indicator Lights will turn green. Watering is enabled during this period.

Available Days

The days available for watering can be programmed in your ET Manager or in your sprinkler controller. Typically Available Watering Days are set to “all” or everyday. Examples of limiting available days include scheduled maintenance, facility use, or local watering restrictions. Depending on your watering situation, your ET Manager can be programmed to water on:

- All days
- Even days
- Odd days
- Odd days with the 31 of the month off
- Custom days

Advanced Settings

Effective Rain Settings

Not all rainfall is effective rain. Rain that falls too quickly will run off before reaching the root zone, and rain that falls when the soil is completely saturated will run off as well. Soil infiltration is the rate at which water enters the soil. Different soil types have different intake rates. The Effective Rain Settings in the ET Manager are based on soil intake rate and soil moisture saturation limits.

Maximum Hourly Rain: The Maximum Hourly Rain is the maximum amount of rain that should be accepted each hour in the soil moisture level. See Table 4 to estimate the Maximum Hourly Rain according to your soil type.

Soil Type	Max Hourly Rain (inches)
Clay	0.10
Silty Clay	0.15
Clay Loam	0.20
Loam	0.35
Sandy Loam	0.40
Loamy Sand	0.50
Sand	0.60

Information from Soil Conservation Service Nation Engineering Handbook, September 1997.

Table 4. Guide to Determine Maximum Hourly Rain

Saturation Allowance: The Saturation Allowance is the amount of rain it takes to saturate the soil after satisfying the Irrigation Amount and before runoff occurs. Saturation Allowance settings are typically half the Irrigation Amount.

Normal watering cycles bring the soil moisture level to field capacity. Heavy rainfall will bring the soil moisture content beyond field capacity to a saturated level (see Figure 14). Additional rainfall beyond this limit can percolate below the root-zone or run-off, and may not be available to the plant. The Saturation Allowance setting represents the difference between field capacity and saturation. The ET Manager uses this amount to limit the total amount of rain that can accumulate in the Moisture Level.

$$\text{Saturation Allowance} + \text{Irrigation Amount} - \text{Current Moisture Level} = \text{Total Allowed Rain}$$

For example, if it rains 1.00”, only 0.65 “of rain will be counted as effective. If the Saturation Allowance is 0.25 “ plus an Irrigation Amount of 0.5” minus a Current Moisture Level of 0.10” = 0.65” of Total Allowed Rain.

Note: A general guideline is to set the Saturation Allowance to half the Irrigation Amount.

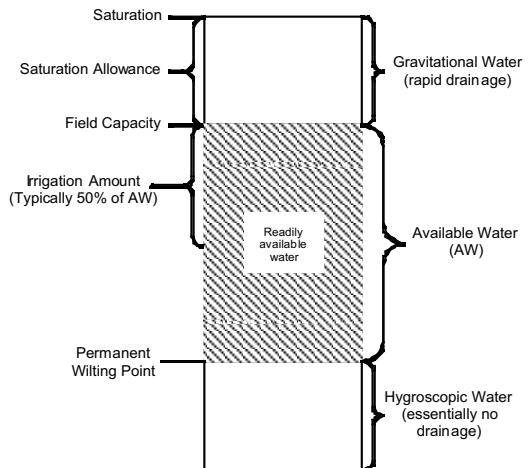

Figure 14. Soil Moisture Holding Capacities

Historical ET

The ET Manager can be set to operate using historical ET data, instead of the weather signal data. If a problem occurs and the ET Manager is not receiving the weather signal, it will continue to operate using historical ET data as a default ET. This setting represents an average daily ET for each month.

Note: A Historical ET database is available in your Rain Bird ET Manager Scheduler program found on the provided CD.

System Settings

Your ET Manager System Settings establishes the source of the weather signal information, how your ET Manager interacts with your sprinkler controller, and other valuable tools. The System Settings details are discussed in chapter 3, Programming.

Your ET Manager System Settings include:

- **Data Source:** The Data Source settings consist of specific settings programmed to access the appropriate weather signal.
- **Options:** Option settings allow you to program the units used (English or Metric) and a security password.
- **Output Method:** The ET Manager can utilize four Output Methods. In most cases, the “Enable” Output Method is the standard method.

When conducting the site assessment, your ET Manager System Settings may have been previously programmed. By documenting these settings, you will be able to verify the settings have been programmed correctly.

ET Manager Scheduler

The Rain Bird ET Manager Scheduler software program, included with your ET Manager, was developed to generate accurate watering schedules. The ET Manager Scheduler uses site-specific information to help you prepare a watering schedule that can be programmed in your sprinkler controller. The ET Manager Scheduler also determines the initial settings for your ET Manager. We encourage using this program for making ET Manager and sprinkler controller programming decisions. The ET Manager Scheduler Operation Guide is available from the CD included with your ET Manager.

7. Troubleshooting

If you have questions or problems with your ET Manager or sprinkler system, this chapter will guide you through possible scenarios that should be considered. The ET Manager Status Report Worksheet, Appendix IX, will help you identify possible errors in programming.

If you are unable to troubleshoot a situation, please contact your installer, Rain Bird Authorized Distributor or Rain Bird Customer Service at www.rainbird.com/etmanager or call Rain Bird Technical Services at 1-877-351-6588.

The following conditions are included in this chapter:

ET Manager Troubleshooting:





- The Display is blank.
- The Attention Indicator Light is on.
- The Valve Group Indicator Light(s) is red and my ET Manager will not let the sprinklers come on.
- The ET Manager is in Override, how do I stop it?

Water Management Troubleshooting:

- How often should my sprinklers come on?
- Evaluate your landscape.
 - Are there dry or wet spots in your landscape?
 - Specific stations within the Valve Group are too dry or too wet.
 - Most stations within the entire Valve Group are too dry or too wet.
- The site is watered every day.
- You want your sprinkler system to water on the next cycle.
- After a rainstorm it resumes watering too soon.
- After a rainstorm it does not resume watering soon enough.
- It was raining and the sprinklers were running.

ET Manager Troubleshooting

The Display is blank.

1. Verify your ET Manager is connected and getting power.
2. LCD Display contrast may need to be adjusted. Press  ten times to get to the LCD contrast screen. Then use  or  to adjust the contrast. You may have to press and hold the  or  for 10 seconds or until the LCD is readable.
3. If steps 1 and 2 do not work, reset your ET Manager by disconnecting the power, and restore the power after 15 seconds.
4. If your ET Manager display remains blank, please contact your installer or Rain Bird.

The Attention Indicator Light is on.

On the Home screen, a message will appear explaining the Attention condition.

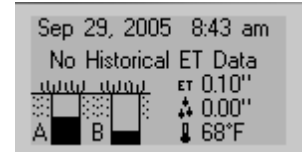

Refer to chapter 5, Routine Operation, for information on each Attention condition.

The Valve Group Indicator Light(s) is red and my ET Manager will not let the sprinklers come on.

If the A or B Indicator Light is red, your ET Manager is interrupting the output of the sprinkler controller. Press the Override button, and the Valve Group A and B Indicator Lights will turn green enabling sprinkler output. Your sprinkler controller can now be used to manually start a valve.

An Override will allow watering for one hour, if more time is needed press the Override button again or press  for each additional hour of Override. Once the over-

7. Troubleshooting

ride time has elapsed watering will be interrupted as before. Press **▼** to 0 hours to end manual override in the ET Manager.

The ET Manager is in Override, how do I stop it?

Press **▼** to 0 hours to end manual override in the ET Manager.

Water Management Troubleshooting

How often should my sprinklers come on?

Your ET Manager uses real-time weather information to determine when watering is needed. Your sprinkler system may water more frequently in the summer months, and less frequently in the spring and fall months since watering is now based on weather (which affects how much water evaporates from your soil). Your ET Manager automatically adjusts throughout the year to keep the Moisture Levels in your soil reservoir at an optimum level for the health of your plants.

Evaluate your landscape.

Before making any adjustments to the settings of either your ET Manager or your automatic sprinkler controller, make sure that the entire sprinkler system is in good working order. It is important to be certain that there are no broken sprinkler heads or broken pipes affecting the performance of your system. Landscapes and automated sprinkler systems are subject to imperfections that can be corrected. **You may need to contact your landscape installer or sprinkler professional.**

1. Perform a walk through evaluation inspecting your sprinkler system while each zone is running.
2. If problems in the sprinkler system are detected, please fix the problems or call sprinkler professionals to assist you.

Are there dry or wet spots in your landscape?

Dry and wet spots are often caused by problems with your sprinkler system or the program in your sprinkler controller. Spots within a station are areas where the plant life is not uniform with the rest of the landscape in the station, and these "spots" are either too dry or too wet.

1. Check the sprinkler heads near the spot that is dry or wet. It is possible that a broken head or nozzle, or a clogged nozzle needs to be replaced.
2. Check the layout of your sprinkler design. Proper sprinkler designs should ensure head to head coverage. Changing a nozzle size, adding or moving a head may improve distribution coverage.
3. If steps 1 and 2 do not solve the problem, check the run times on your sprinkler controller. Adding additional run time for the station where the spot appears may compensate for minor sprinkler system inefficiencies.

Note: Adjust the run time using small intervals of time. Monitor the spots after an adjustment has been made. This will help determine what run time is optimal to prevent dry or wet spots.

Specific stations within the Valve Group are too dry or too wet.

Stations are the distinct areas in your landscape watered by one valve in Valve Group A or B. Dry or wet stations are often caused by a run time problem programmed in your sprinkler controller.

1. Check the run time on your sprinkler controller for this station. The dry or wet station can be caused by too little or too much watering time for that station.
2. Manually water the station if it is too dry to get it the water it needs.

Note: Adjust the run time using small intervals of time. This will help determine what run time is optimal to prevent dry or wet zones.

Most stations within the entire Valve Group are too dry or too wet.

There are two possible causes of all the stations within entire Valve Group being too dry or too wet:

- The Irrigation Amounts for A or B were not correctly programmed.
- A run time problem programmed in your sprinkler controller.

If your Valve Group is overly dry, water the stations in the Valve Group by following the steps outlined in “**You want your sprinkler system to water on the next cycle**” pg. 51 .

Please follow these steps:

1. Check the run times on your sprinkler controller. The dry or wet Valve Group can be caused by too little or too much run time for each station in the Valve Group.
2. Adjust the run time using small intervals of time. This will help determine what run time is optimal to prevent dry or wet stations.
3. If steps 1 and 2 do not fix this problem, you should adjust the Irrigation Amounts in the ET Manager.
4. Increase or decrease your Irrigation Amounts for Valve Group A or B.

Main Menu ► Settings ► Irrigation Control
► Irrigation Amount & Adjust

Increasing the Irrigation Amount decreases the frequency of watering and decreasing the Irrigation Amount increases the frequency of watering. You want to increase your Irrigation Amount if you are experiencing a wet Valve Group and you want to decrease your Irrigation Amount if you have a dry Valve Group.

Refer to chapter 6, Determining Programmable Settings, for more information to properly adjust the Irrigation Amount values.

The site is watering every day.

There are three possible causes of why the site is watering everyday:

- The Irrigation Amounts for A or B are programmed too low.
 - The Automatic Window is not correctly programmed.
 - The ET Manager was not properly installed.
1. The Irrigation Amounts for Valve Group A or B could be too low. Refer to chapter 6, Determining Programmable Settings, for more information to properly adjust the Irrigation Amount values.

Main Menu ► Settings ► Irrigation Control
► Irrigation Amount & Adjust

2. The Automatic Window setting may not be synchronized to the time of day when watering is scheduled to occur in the sprinkler controller. If the watering cycle occurs outside the programmed Automatic Window, watering is not detected and the Current Moisture Level(s) is not adjusted. Refer to chapter 3, Programming, for more information on programming the Automatic Window.

Main Menu ► Settings ► Irrigation Control
► Water Window ► Automatic Window

3. Wiring is not properly installed. Follow the Valve Control Test steps outlined in chapter 4, System Check. If test fails, wiring is not properly installed.

7. Troubleshooting

You want your sprinkler system to water on the next cycle.

There may be occasions when, in your judgment, the sprinklers should water tonight or the next watering cycle. When the Valve Group A or B Indicator Light is green, then watering will be allowed during the next scheduled cycle. If the Valve Group A or B Indicator Light is red and you want to allow the next scheduled cycle to come on, then adjust the Current Moisture Level for Valve Group A and/or B to allow watering.

1. Determine which Valve Group A or B you want to run. Remember the A and B Moisture Levels are specific to types of plants (e.g. lawn and shrubs).
2. Decrease the A or B Moisture Level to zero.

Main Menu ► Irrigation Status
► “A” or “B” Moisture Level

3. Once the level reaches zero the red Valve Group Indicator Light will change to green and your ET Manager will allow your sprinkler system to water a complete cycle once the Automatic Window is open.

Note: The Valve Group Indicator Light(s) will not turn green if the Automatic Window is open, or if the current day is a no water day. If either of these conditions is occurring, the Home screen will notify you.

After a rainstorm my sprinkler system resumes watering too soon.

Walk through each step below to prevent your sprinkler system from watering too soon after a rainstorm.

1. The location of your optional rain gauge may be poorly sited. Make certain there are no obstacles blocking rain from entering the rain gauge.
2. Check the Rain Source to verify the ET Manager is programmed to the correct source, specifically when using an optional rain gauge.

Main Menu ► Settings ► System
► Data Source ► Rain Source

3. The Maximum Hourly Rain setting may be limiting the amount of rainfall applied to the Moisture Levels. Change the Maximum Hourly Rain to a higher amount to allow the ET Manager to accept more rainfall in the Moisture Levels for Valve Group A and B.

Main Menu ► Settings ► Irrigation Control
► Advanced Settings ► Effective Rain Settings
► Max Hourly Rain

4. The Saturation Allowance for A or B may be too low. Change the Saturation Allowance to a higher amount to allow the ET Manager to accept more rainfall in the Moisture Levels for Valve Group A and B.

Main Menu ► Settings ► Irrigation Control
► Advanced Settings ► Effective Rain Settings
► Saturation Allowance A or B

5. The weather signal rainfall value may not correctly represent rainfall at your site. Connect an optional rain gauge, see chapter 2, Installation.

After a rainstorm my sprinkler system does not resume watering soon enough.

If your sprinkler system does not resume watering soon enough after a rainstorm, follow these steps:

1. Check the Rain Source to verify the ET Manager is programmed to the correct source, specifically when using an optional rain gauge.

Main Menu ► Settings ► System
► Data Source ► Rain Source

2. Lower the Max Hourly Rain setting for Valve Group A or B. The Maximum Hourly Rain setting may be limiting the amount of rainfall applied to the Moisture Levels. Change the Maximum Hourly Rain to a lower amount to allow the ET Manager to limit rainfall in the Moisture Levels for Valve Group A or B.

Main Menu ► Settings ► Irrigation Control
► Advanced Settings ► Effective Rain Settings
► Max Hourly Rain

3. The Saturation Allowance for A or B may be too high. Lower the Saturation Allowance settings for Valve Groups A or B. The Saturation Allowances for A and B create a limit to the amount of rain that can accumulate in the Moisture Levels. The ET Manager uses this amount to limit the total amount of rain that can accumulate in the Moisture Level.

Main Menu ► Settings ► Irrigation Control
► Advanced Settings ► Effective Rain Settings
► Saturation Allowance A or B

4. The weather signal rainfall value may not correctly represent rainfall at your site. Connect an optional rain gauge, see chapter 2, Installation.

It was raining and the sprinklers were running.

1. Check the Weather Info for the last hour of rain to verify rain data is being reported by your ET Manager.

Main Menu ► Weather Info ► Rain

2. Check the Rain Source to verify the ET Manager is programmed to the correct source to ensure the rain data is correct.

Main Menu ► Settings ► System
► Data Source ► Rain Source

3. Program a 1 Hour Rain Interrupt to interrupt watering until rain accumulations reach below the programmed Rain1 Hour setting. See chapter 3, Programming, for more information.

Main Menu ► Settings ► Weather Interrupt
► Rain 1 Hour Rain

4. Program a 24 Hour Rain Interrupt to interrupt watering until rain accumulations reach below the programmed Rain 24 Hour setting. See chapter 3, Programming, for more information.

Main Menu ► Settings ► Weather Interrupt
► Rain 24 Hour Rain

Note: Remember that small amounts of rainfall may not be enough to warrant a 1 Hour or 24 Hour Rain Interrupt.

Note: If the Moisture Level for Valve Group A or B is equal to zero at the opening of the Automatic Window, sprinkling will remain enabled throughout the Automatic Window unless 1 Hour or 24 Hour Rain Interrupts are programmed. Rain that falls during normal watering cycle will be accounted for in the Moisture Levels for Valve Group A and B.

Rain Bird Note: New models of the Rain Bird ESP controller family offer a “RASTER” test, which is used to diagnose electrical problems with the sprinkler system. Before executing the RASTER test press the Override button on the ET Manger to enable the controller common.

8. Advanced Output Methods

The ET Manager is an accessory to a sprinkler controller to provide real-time ET based water management for the sprinkler system. The interface between your sprinkler controller and the ET Manager utilizes one of four different Output Methods. The capabilities of the sprinkler controller and site-specific needs determine which Output Mode should be used. To determine which Output Method is used with your sprinkler controller, please review this chapter.

Output Methods

- **Enable:** This is the most common setting. A sprinkler controller output is enabled to allow watering only when needed.
- **Enable A then B:** This output operates the same as the “Enable” method with one significant difference. There may be instances when watering needs to be spread over two days. The A then B mode allows watering on only one valve group per day, then alternates to the other valve group on the next available day.
- **ET and Rain Pulse:** ET-based controllers can recognize these inputs. A dry contact switch closure signal represents 0.01” of ET. The rain output signals 0.01” of rain.
- **ET Pulse with Weather Interrupt:** ET Pulse with Weather Interrupt is similar to ET and Rain Pulse with a second output acting as a sensor interrupt to prevent watering if any one of the three Weather Interrupt conditions occurs; rain, freezing conditions or high wind. A dry contact switch closure signal represents 0.01” of ET.

This chapter focuses on all Output Methods except Enable.

Enable A then B

Some sites need to spread watering over 2 days, watering a portion the site one night and the remaining site the next night. The “Enable A then B” Output Method separates watering of Valve Group A and B over a two day period. The Enable A then B Output Method operates the same as the Enable mode described in this manual with the difference that the valve groups will never water during the same Automatic Window; Valve Group A waters one night “then” B the next night. In order to implement the Enable A then B Output Method:

- Your sprinkler controller, ET Manager, and valves must be installed correctly, see Figure 15.
- Your ET Manager must be correctly programmed.
- Your sprinkler controller must be programmed correctly.

Wiring “A Then B”

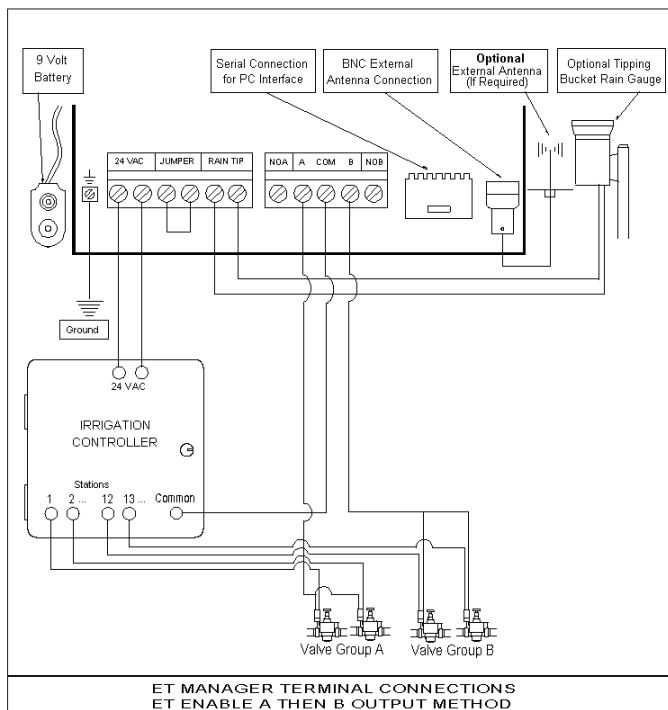

Figure 15. ET Manager Terminal Connections ET Enable A Then B

Mounting and installation is the same as the Enable Output Method. The difference is the Valve Group wiring. Divide the valves into 2 valve common wire groups, one for Valve Group A and the other for Valve Group B. Valves to be watered in one 24-hour period must be on a separate “common wire” from those watered in the next 24-hour period, where valves in Valve Group A must be connected to the A wire terminal and valves in Valve Group B must be connected to the B wire terminal on your ET Manager.

ET Manager Programming for “A Then B”

All programming of your ET Manager is the same as described in the manual for the Enable mode with the following exceptions:

1. The Output Method must be set to Enable A then B.

Main Menu ► Settings ► System
 ► Output Method ► Enable A then B

2. The Irrigation Amount and Landscape Adjustment settings can be different to accommodate specific site needs. In this instance, the resulting frequency may be different causing the sequence to change. For example, if

Valve Group A watered one night and the next night Valve Group B does not need to water but Valve Group A needs to be watered, then A would water again, hence changing the sequence. This is not a problem, but be aware that the sequence could change.

3. Automatic Window settings need to encompass the water window for both programs in the controller. For example, if program A is set to start at 10:00 PM and finish at 4:00 AM and program B is set to start at 11:00 PM and finish at 6:00 AM, the Automatic Window should be set to start at 10:00 PM and run for 8 and a half hours to close at 6:30 AM.

Programming the Sprinkler Controller for “A Then B”

There are several essential steps to follow when programming the sprinkler controller for the ET Manager to water Valve Group A one day “then” Valve Group B the next day.

1. Valves wired to each Valve Group (A and B) must be assigned to separate programs in the sprinkler controller. For example, valves in Valve Group A should be assigned to Program A in the sprinkler controller.
2. Each sprinkler controller program should be set to the same time.
3. The sprinkler controller **MUST** support the option to “overlap” programs. Both programs must run at the same time. Even though the sprinkler controller will attempt to operate both programs at the same time, the ET Manager will only allow one valve group to operate at a time.
4. Station run times need to be programmed to apply enough water to satisfy the Irrigation Amounts programmed in your ET Manager.
5. Note the earliest start time for both programs and the ending time for the last program. This will be needed to program the Automatic Window in your ET Manager.

ET & Rain Pulse

There are compatible advanced ET-based sprinkler controllers that can use the ET Manager as an ET source. Some ET-based controllers accept a pulse input as an ET source; a momentary switch closure for each 0.01” of ET. They often have a similar input for rain. The sprinkler controller uses these values to automatically adjust watering schedules.

The ET Manager has an ET and Rain pulse output that provides a dry contact switch closure representing 0.01” of ET and 0.01” of rain. The rain data comes from the selected rain source. To utilize the ET and Rain Pulse Output Method:

- Your sprinkler controller, ET Manager, and valves must be installed correctly, see Figure 16.
- Your ET Manager must be correctly programmed.
- Your sprinkler controller must be programmed to recognize pulse inputs.

Note: When using this Output Method, all scheduling decisions including days of operation are made by the sprinkler controller. The ET Manager simply inputs the ET and rain data to the sprinkler controller.

Wiring ET and Rain Pulse

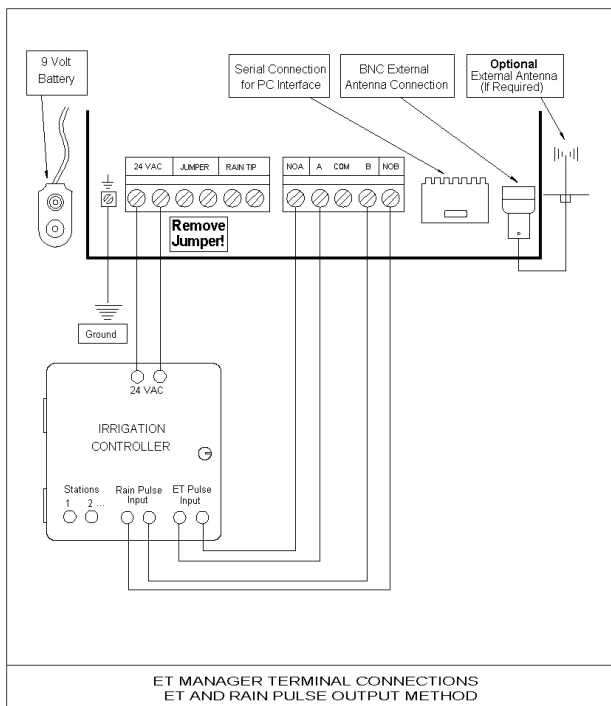

Figure 16. ET Manager Terminal Connections ET and Rain Pulse

The processes of mounting, grounding, and connecting the power source are the same as the Enable Output Method. Complete the following steps to install your ET Manager using the ET and Rain Pulse Output Method:

1. You **MUST** remove the jumper wire connecting the “Jumper” terminals.
2. Connect two wires from the ET pulse sensor input from the sprinkler controller to the NOA and A terminals on the ET Manager.
3. Connect two wires from the rain pulse sensor input from the sprinkler controller to the NOB and B terminals on the ET Manager.

ET Manager Programming using ET and Rain Pulse

There are several settings that must be correctly programmed in your ET Manager. These settings are different for each sprinkler controller. Check the input requirements of the sprinkler controller before programming your ET Manager. The following settings need to be made:

1. The Output Method must be set to ET & Rain Pulse.

Main Menu ► Settings ► System
 ► Output Method ► ET & Rain Pulse

2. There are three settings in the Pulse menu:

Main Menu ► Settings ► System ► Pulse

a. Per Minute: There are two options either 1 or 10 pulses per minute. This setting controls the pulse rate so the host sprinkler controller can recognize each pulse.

b. ET Duration: For each 0.01" of ET a dry contact switch closure is made. The number of seconds the switch remains closed for each pulse is programmed here.

c. Rain Duration: For each 0.01" of rain a dry contact switch closure is made. The number of seconds the switch remains closed for each pulse is programmed here.

3. Standard Enable settings that are the same:

a. Irrigation Control

i. Advanced Settings

1. Signal Crop Coefficient
2. Wind Adjust Percentage
3. Historical ET

b. System

i. Data Source

1. Weather Region
2. Rain Source
3. Elevation
4. Signal Provider Code

ii. Options

1. Units
2. Password

Sprinkler Controller Programming using ET and Rain Pulse

Every ET-based controller implements ET and Rain inputs differently. Wiring, settings, programming, and operations should be described in the users guide for your sprinkler controller.

Note: Application notes detailing installation and settings for specific compatible controllers are available at www.rainbird.com/etmanager.

ET Pulse with Weather Interrupt

The ET Pulse with Weather Interrupt functions the same as the ET and Rain Pulse Output Method by utilizing Weather Interrupt instead of a Rain Pulse. To utilize this Output Method:

- Your sprinkler controller, ET Manager, and valves must be installed correctly, see Figure 17.
- Your ET Manager must be correctly programmed.
- Your sprinkler controller must be programmed to recognize ET pulse input and Weather Interrupt control.

Wiring ET Pulse with Weather Interrupt

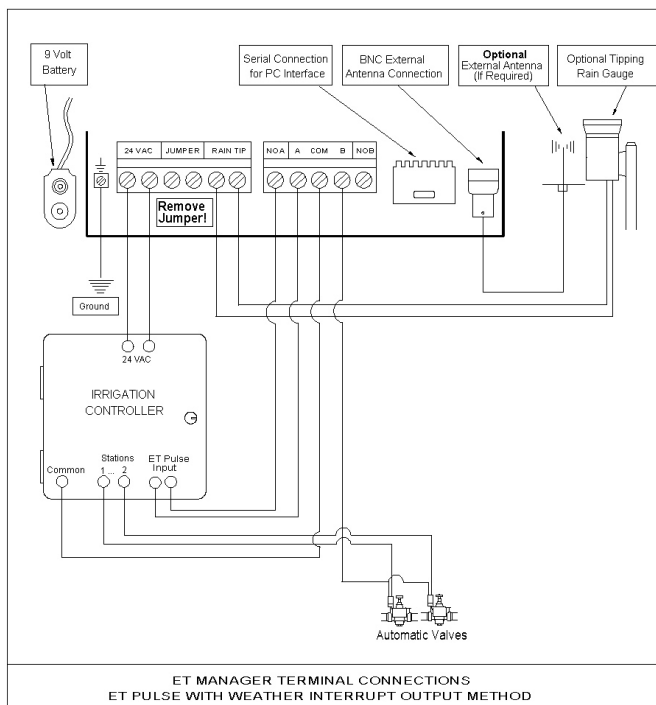

Figure 17. ET Manager Terminal Connections ET Pulse with Weather Interrupt

The processes of mounting, grounding, and connecting the power source are the same as for the Enable Output Method. Complete the following steps to connect the ET and Weather Interrupt circuit:

1. You **MUST** remove the jumper wire connecting the “Jumper” terminals.
2. Connect two wires from the ET pulse sensor input from the sprinkler controller to the NOA and A terminals on the ET Manager.
3. Route the sprinkler controller valve common through the “Com” and “B” terminals on the ET Manager.

ET Manager Programming using ET Pulse with Weather Interrupt

There are several settings in your ET Manager that must be set correctly for ET Pulse with Weather Interrupt. The settings are different for each sprinkler controller. Check the input requirements of the controller before programming your ET Manager. The following settings need to be made:

1. The Output Method must be set to ET Pulse with Interrupt.

Main Menu ► Settings ► System
 ► Output Method ► ET Pulse with Interrupt

2. There are two settings in the Pulse menu:

Main Menu ► Settings ► System ► Pulse

a. Per Minute: There are two options either 1 or 10 pulses per minute. This setting controls the pulse rate so the host sprinkler controller can recognize each pulse.

b. ET Duration: For each 0.01" of ET a dry contact switch closure is made. The number of seconds the switch remains closed for each pulse is programmed here.

3. Standard Enable settings that are the same:

- a. Irrigation Control
 - i. Advanced Settings
 1. Signal Crop Coefficient
 2. Wind Adjust Percentage
 3. Historical ET
 - b. System
 - i. Data Source
 1. Weather Region
 2. Rain Source
 3. Elevation
 4. Signal Provider Code
 - ii. Options
 1. Units
 2. Password
 - c. Weather Interrupt
 - i. Temperature
 - ii. Wind
 - iii. Rain 24 Hour
 - iv. Rain 1 Hour

Note: When using the ET Pulse with Weather Interrupt Output Method, the Valve Group B Indicator light will turn green. If a Weather Interrupt condition occurs, the Valve Group B Indicator Light will turn red to notify you of the interrupt.

Sprinkler Controller Programming using ET Pulse with Weather Interrupt

Every ET-based controller implements ET inputs differently. Wiring, settings, programming, and operations should be described in the users guide for your sprinkler controller. The Weather Interrupt overrides the sprinkler controller output.

Note: Application notes detailing installation and settings for specific compatible controllers are available at www.rainbird.com/etmanager.

Using More than One Sprinkler Controller

An ET Manager controls a single sprinkler controller. On large projects with more than one controller the hydraulic capabilities of the sprinkler system may limit the number of valves that operate at a time. Often schedules are set up so one group of clocks waters one night then the other clock waters the next night. With the ET Manager this can be accomplished one of two ways.

- The Available Day feature on the ET Manager can limit watering to specific days. For example one ET Manager can be programmed to water on odd days and the other could be set to water even days.
- Another approach is to use the “Enable A then B” Output Method described in this chapter. The Enable A then B Output Method allows Valve Group A to water one night “then” B to water the next night.

9. Appendices

The following supplemental recourses are included:

1. Appendix I. ET Manager Menu Structure
2. Appendix II. General ET Manager Settings
3. Appendix III. ET Manager Site Assessment Worksheet
4. Appendix IV. Soil Texture by Feel Diagram
5. Appendix V. Calculating Precipitation Rates and Station Run Times
6. Appendix VI. ET Manager Settings Worksheet
7. Appendix VII. Sprinkler Controller Programming Worksheet
8. Appendix VIII. ET Manager System Checklist
9. Appendix IX. ET Manager Troubleshooting Worksheet
10. Appendix X. Master Valve and Pump Control Installation with ET Manager

Printable versions of the Worksheet Appendices are available to download and print from www.rainbird.com/etmanager or the CD included with your ET Manager.

Appendix I. ET Manager Menu Structure

- Weather Info
 - Rain
 - Last Hour
 - Last 24 hours
 - Last 7 Days
 - Graph
 - Temperature
 - Current
 - High Today
 - Low Today
 - Graph
 - Wind
 - Current
 - High Today
 - Low Today
 - Graph
 - Humidity
 - Current
 - High Today
 - Low Today
 - Graph
- Irrigation Status
 - A Moisture Level
 - Irrigation Amount
 - Current Level
 - Graph
 - B Moisture Level
 - Irrigation Amount
 - Current Level
 - Graph
 - Rain
 - Last Hour
 - Last 24 hours
 - Last 7 Days
 - Graph

9. Appendices

- Evaporation (ET)
 - Last Hour
 - Last 24 hours
 - Last 7 Days
 - Signal Crop Coefficient %
 - Graph
- Information Log
 - A Irrigation Log
 - Last Watering
 - Days Watered
 - Total Water
 - Since
 - Clear
 - Graph
 - B Irrigation Log
 - Last Watering
 - Days Watered
 - Total Water
 - Since
 - Clear
 - Graph
 - Last Interrupt
 - Cause, date and time
 - Weather Signal
 - Last Signal
 - Accuracy
 - Signal Detect
 - Test Counter
 - Reset
- Settings
 - Irrigation Control
 - Irrigation Amount and Landscape Adjustment % for Valve Group A and B
 - Water Window
 - Automatic
 - Daily
 - Available Watering Days
 - All, Odd, Odd with 31st Off, Even, Custom Days
 - Advanced Setting
 - Effective Rain Settings
 - Maximum Hourly Rain
 - Saturation Allowance A
 - Saturation Allowance B
 - Signal Crop Coefficient
 - Wind Adjust %
 - Historical ET
 - January - December
 - System
 - Data Source
 - Weather Region
 - Rain Source
 - Elevation
 - Signal Provider Code
 - Options
 - Units
 - Password
 - Clear Data
 - Defaults
 - Output Method
 - Enable
 - Enable A then B
 - ET and Rain Pulse
 - ET Pulse with Interrupt
 - Pulse
 - Per Minute
 - ET Duration
 - Rain Duration
 - Date and Time
 - Weather Interrupt
 - Low Temperature
 - High Wind
 - Rain 24 Hour
 - Rain 1 Hour
- Control Mode
 - Automatic
 - Historical ET
 - Disabled
 - Override

Appendix II: Default ET Manager Settings



ET Manager Default Settings

Irrigation Control			
	Valve Group A (Typically Lawn)		Valve Group B (Typically Shrub)
Irrigation Amount:	0.5"		0.75"
Landscape Adjustment:	100%		75%
Available Watering Days:	All		All
Max Hourly Rain:	0.25"		
Saturation Allowance:	0.25"		0.35"
System			
Output Method:	Enable		
Weather Interrupt			
Temperature Interrupt:	30 ° F		
Wind Interrupt:	120 mph		
Rain 24 Hour Interrupt:	0.30"		
Rain 1 Hour Interrupt:	0.15"		
Water Window			
	Start Time	Window Length	End Time
Automatic Window	2:00 AM	6 hours	8:00 AM
Daily Window	Off	0 hours	Off
Rain Bird Technical Service: 1-877-351-6588			

P-500-20

Appendix III. ET Manager Site Assessment Worksheet



ET Manager Site Assessment Worksheet

Site Name:				Date:			
Address:							
Sprinkler Controller Type:							
ET Manager Installation Location:						<input type="checkbox"/> Outdoor Enclosure	
Sprinkler Controller Station Information							
Station	Description	Valve Group <input type="checkbox"/> A <input type="checkbox"/> B <input type="checkbox"/> None	Sprinkler Type & Precipitation Rate (or Spacing, Nozzle, PSI, Radius, GPM)	Exposure	Slope		
					0-3%	4-6%	7-12% 13% +
1		<input type="checkbox"/> A <input type="checkbox"/> B <input type="checkbox"/> None					
2		<input type="checkbox"/> A <input type="checkbox"/> B <input type="checkbox"/> None					
3		<input type="checkbox"/> A <input type="checkbox"/> B <input type="checkbox"/> None					
4		<input type="checkbox"/> A <input type="checkbox"/> B <input type="checkbox"/> None					
5		<input type="checkbox"/> A <input type="checkbox"/> B <input type="checkbox"/> None					
6		<input type="checkbox"/> A <input type="checkbox"/> B <input type="checkbox"/> None					
7		<input type="checkbox"/> A <input type="checkbox"/> B <input type="checkbox"/> None					
8		<input type="checkbox"/> A <input type="checkbox"/> B <input type="checkbox"/> None					
9		<input type="checkbox"/> A <input type="checkbox"/> B <input type="checkbox"/> None					
10		<input type="checkbox"/> A <input type="checkbox"/> B <input type="checkbox"/> None					
11		<input type="checkbox"/> A <input type="checkbox"/> B <input type="checkbox"/> None					
12		<input type="checkbox"/> A <input type="checkbox"/> B <input type="checkbox"/> None					
13		<input type="checkbox"/> A <input type="checkbox"/> B <input type="checkbox"/> None					
14		<input type="checkbox"/> A <input type="checkbox"/> B <input type="checkbox"/> None					
15		<input type="checkbox"/> A <input type="checkbox"/> B <input type="checkbox"/> None					
16		<input type="checkbox"/> A <input type="checkbox"/> B <input type="checkbox"/> None					
17		<input type="checkbox"/> A <input type="checkbox"/> B <input type="checkbox"/> None					
18		<input type="checkbox"/> A <input type="checkbox"/> B <input type="checkbox"/> None					
19		<input type="checkbox"/> A <input type="checkbox"/> B <input type="checkbox"/> None					
20		<input type="checkbox"/> A <input type="checkbox"/> B <input type="checkbox"/> None					
Landscape Conditions							
Valve Group:	Plant Type:		Soil Type:		Root Depth (in):		
A							
B							

Rain Bird Technical Service: 1-877-351-6588

P-500-23

Appendix IV. Soil Texture by Feel Diagram

Source: "A Flow Diagram for Teaching Texture-by-Feel Analysis" published in the Journal of Agronomic Education by Steve J. Thien, Vol. 8, 1979. pp. 54-55.

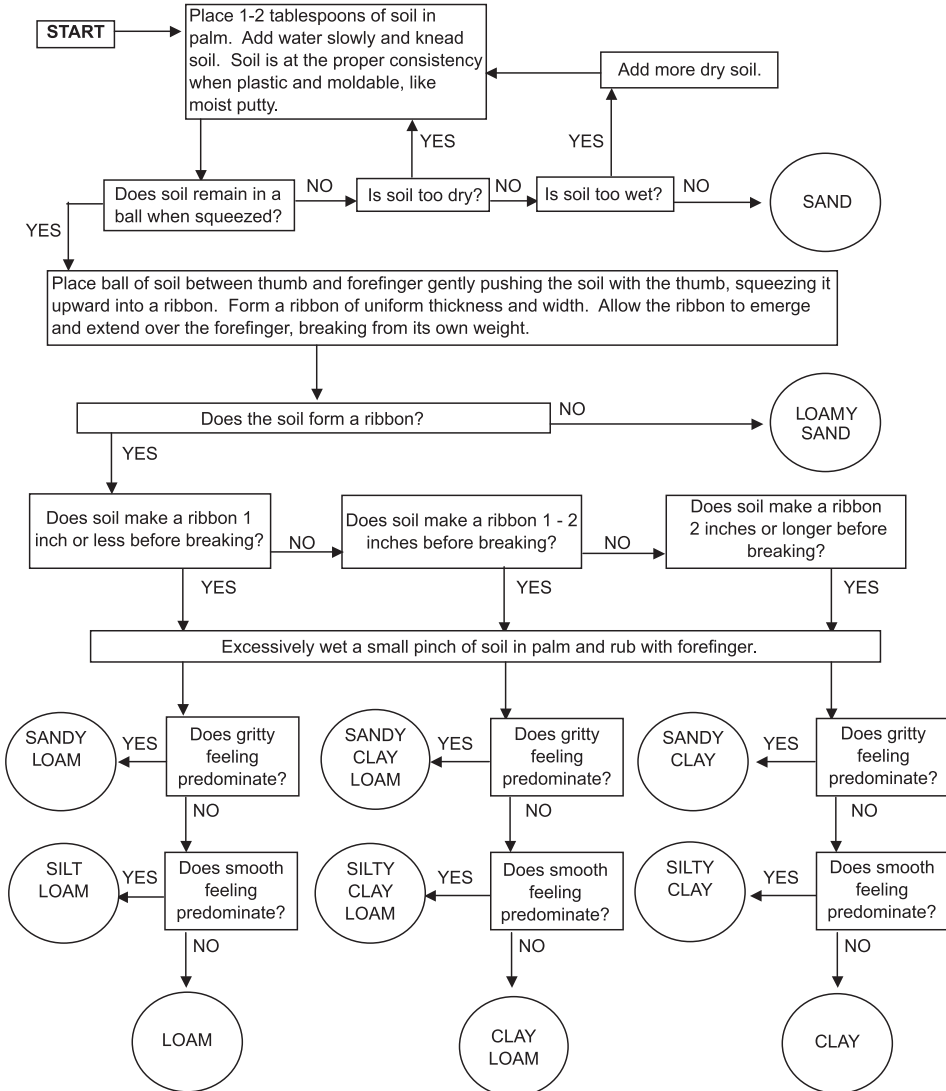

Appendix V. Calculating Precipitation Rates and Station Run Times

Precipitation Rate

Each station in a sprinkler system applies water at a given rate, known as the precipitation rate, expressed in inches per hour. Precipitation rates vary based on the sprinkler type, spacing, nozzle, pressure, and sprinkler layout. There are three ways to determine the precipitation rate:

Option 1: Refer to the manufacturer sprinkler performance charts.

Option 2: Use the industry accepted precipitation rate formula:

$$\text{Precipitation rate (in/hr)} = \frac{96.25 \times \text{Sprinkler Gallons per Minute (gpm)}}{\text{Sprinkler Head Spacing (ft)} \times \text{Sprinkler Row Spacing (ft)}}$$

Note: 96.25 is a constant used as a conversion factor

Option 3: Perform a catch can test to measure the amount of water applied by the sprinklers in a given time period. The following formula

$$\text{Precipitation rate (in/hr)} = \frac{\text{Average Catch Can Value}}{\text{Catch Can Test Duration (minutes)}} \times \frac{60 \text{ Minutes}}{1 \text{ Hour}}$$

Station Run Time

Station run time is based on the Irrigation Amount and precipitation rate. For example, if the Irrigation Amount is 0.5” and the precipitation rate of the sprinklers for a station is 1.5” per hour, the station must run for 20 minutes to apply 0.5” of water.

You can calculate the station run time using the precipitation rate and the Irrigation Amount:

$$\text{Run Time} = \frac{\text{Irrigation Amount} \times 60}{\text{Precipitation Rate}}$$

Note: The station run time may need to be adjusted based on the sprinkler distribution uniformity.

Appendix VI. ET Manager Settings Worksheet



ET Manager Settings Worksheet

Site Name:		Date:									
Customer:		Contact:									
Phone:		Serial #:									
Address:											
Date Installed:	Installer:	Phone:									
Sprinkler Controller Type:		Location of Unit:									
Controller Start Times:		Days Set to Irrigate:									
Irrigation Control											
Irrigation Amount & Adj: Irrigation Amount: A: B: Landscape Adjustment: A: % B: %											
Water Window: Automatic Window:		Daily Window:									
Available Watering Days: <input type="checkbox"/> All <input type="checkbox"/> Odd <input type="checkbox"/> Odd 31st Off <input type="checkbox"/> Even <input type="checkbox"/> Custom: <input type="checkbox"/> S <input type="checkbox"/> M <input type="checkbox"/> T <input type="checkbox"/> W <input type="checkbox"/> Th <input type="checkbox"/> F <input type="checkbox"/> Sa											
Advanced Settings:											
Effective Rain Settings - Max Hourly Rain: inches per hour											
Saturation Allowance "A": inches		Saturation Allowance "B": inches									
Wind Adjust: %		Signal Crop Coefficient: <input type="checkbox"/> Use <input type="checkbox"/> Ignore									
Historical ET: (Daily ET)											
Jan:	Feb:	Mar:	April:	May:	June:	July:	Aug:	Sept:	Oct:	Nov:	Dec:
System											
Data Source - Weather Region:						Elevation:					
Rain Source : <input type="checkbox"/> Signal <input type="checkbox"/> Local (1mm per tip) <input type="checkbox"/> Local (0.01" per tip) <input type="checkbox"/> Rain Region:											
Signal Provider Code: A: B: C: D: E: F: G: H: I: J:											
Options - Units: <input type="checkbox"/> English <input type="checkbox"/> Metric						Password: <input type="checkbox"/> No <input type="checkbox"/> Yes, Password:					
Output Method: <input type="checkbox"/> Enable <input type="checkbox"/> Enable A then B <input type="checkbox"/> ET & Rain Pulse <input type="checkbox"/> ET Pulse with Weather Interrupt											
If using Pulse: Pulses per Minute:				Rain Pulse Duration: seconds				ET Pulse Duration: seconds			
Weather Interrupt											
Temperature Interrupt:						Wind Interrupt:					
Rain 24 Hour Interrupt:						Rain 1 Hour Interrupt:					
Notes & Adjustments:											
Rain Bird Technical Service: 1-877-351-6588											

Appendix VII. Sprinkler Controller Programming Worksheet



Sprinkler Controller Programming Worksheet

ET Manager Settings	Available Watering Days	Program A	Program B	Program C	Program D		
		S M T W Th F Sa	S M T W Th F Sa	S M T W Th F Sa	S M T W Th F Sa		
		Odd or Even	Odd or Even	Odd or Even	Odd or Even		
Irrigation Amount A:	Start Times						
Landscape Adjustment A:	1						
Irrigation Amount B:	2						
Landscape Adjustment B:	3						
Automatic Window:	4						
Daily Window:	5						
	6						
	7						
	8						
Stations							
	Location	Valve Group	Sprinkler Type	Run Time	Run Time	Run Time	Run Time
1		<input type="checkbox"/> A <input type="checkbox"/> B					
2		<input type="checkbox"/> A <input type="checkbox"/> B					
3		<input type="checkbox"/> A <input type="checkbox"/> B					
4		<input type="checkbox"/> A <input type="checkbox"/> B					
5		<input type="checkbox"/> A <input type="checkbox"/> B					
6		<input type="checkbox"/> A <input type="checkbox"/> B					
7		<input type="checkbox"/> A <input type="checkbox"/> B					
8		<input type="checkbox"/> A <input type="checkbox"/> B					
9		<input type="checkbox"/> A <input type="checkbox"/> B					
10		<input type="checkbox"/> A <input type="checkbox"/> B					
11		<input type="checkbox"/> A <input type="checkbox"/> B					
12		<input type="checkbox"/> A <input type="checkbox"/> B					
13		<input type="checkbox"/> A <input type="checkbox"/> B					
14		<input type="checkbox"/> A <input type="checkbox"/> B					
15		<input type="checkbox"/> A <input type="checkbox"/> B					
16		<input type="checkbox"/> A <input type="checkbox"/> B					
17		<input type="checkbox"/> A <input type="checkbox"/> B					
18		<input type="checkbox"/> A <input type="checkbox"/> B					
19		<input type="checkbox"/> A <input type="checkbox"/> B					
20		<input type="checkbox"/> A <input type="checkbox"/> B					
21		<input type="checkbox"/> A <input type="checkbox"/> B					
22		<input type="checkbox"/> A <input type="checkbox"/> B					
23		<input type="checkbox"/> A <input type="checkbox"/> B					
24		<input type="checkbox"/> A <input type="checkbox"/> B					

Rain Bird Technical Service: 1-877-351-6588

Appendix VIII: ET Manager Installation Checklist



ET Manager Installation Checklist

Site Name:	Installation Date:
Address:	
Owner:	
Installer:	
Sprinkler Controller Type:	
Installing and Mounting ETMI	
ET Manager Installation Location:	
Mounted in location protected from the weather: <input type="checkbox"/> Yes <input type="checkbox"/> No	
Outdoor Enclosure Required: <input type="checkbox"/> Yes <input type="checkbox"/> No	
Connect Power Source	
ET Manager Correctly Grounded: <input type="checkbox"/> Yes <input type="checkbox"/> No	
Power Source: <input type="checkbox"/> Sprinkler Controller, 24 VAC <input type="checkbox"/> Plug in transformer ETMI-TRAN Power Connected: <input type="checkbox"/> Yes <input type="checkbox"/> No	
9 Volt Alkaline Battery Installed: <input type="checkbox"/> Yes <input type="checkbox"/> No	
Connect Common Wire	
Common Wire from ETMI to Sprinkler Controller: <input type="checkbox"/> Yes <input type="checkbox"/> No	
Using ETMI Valve Group A: <input type="checkbox"/> Yes <input type="checkbox"/> No	Using ETMI Valve Group B: <input type="checkbox"/> Yes <input type="checkbox"/> No
ETMI Valve Group A/B Wired to Station Valves: <input type="checkbox"/> Yes <input type="checkbox"/> No	
Program Weather Signal Settings	
Signal Provider Code Programmed: <input type="checkbox"/> Yes <input type="checkbox"/> No	Weather Region:
Rain Source: <input type="checkbox"/> Signal <input type="checkbox"/> Local (1mm per tip)(ETM-RG) <input type="checkbox"/> Local (0.01" per tip) <input type="checkbox"/> Rain Region:	
Complete Weather Signal Test: Signal Detected: <input type="checkbox"/> Yes <input type="checkbox"/> No	
Historical ET Programmed: <input type="checkbox"/> Yes <input type="checkbox"/> No	
Complete Valve Control Test	
Valve Control Test Valve Group A Completed: <input type="checkbox"/> Yes <input type="checkbox"/> No	
Valve Control Test Valve Group B Completed: <input type="checkbox"/> Yes <input type="checkbox"/> No	
Program an Irrigation Amount	
Irrigation Amount: Valve Group A:	Valve Group B:
Program Sprinkler Controller	
Programmed Sprinkler Controller Start Times: <input type="checkbox"/> Yes <input type="checkbox"/> No	
Programmed Sprinkler Controller Station Run Times: <input type="checkbox"/> Yes <input type="checkbox"/> No	
Programmed Sprinkler Controller to Water Everyday: <input type="checkbox"/> Yes <input type="checkbox"/> No	
Program Water Window Settings	
Water Window: Automatic Window:	Daily Window:
Verify Sprinkler Controller Start Times Match the Water Windows: <input type="checkbox"/> Yes <input type="checkbox"/> No	
Notes	
Rain Bird Technical Service: 1-877-351-6588	

Appendix X. Master Valve and Pump Control Installation with ET Manager

Master valve and pump control can be utilized with your ET Manager. Please carefully read the given methods below when using master valve and pump control with your ET Manager.

Master Valve Control

There are three options for using the sprinkler master valve:

1. Use two isolation relays and a separate common. This is the safest scheme to use the sprinkler master valve.

2. Use a separate common only. This scheme is constrained because the master valve will turn on with every sprinkling cycle, even when valves are not actually watering.
3. Use Valve Group A only by routing the same common to the master valve and the sprinkler valves. This method is limited to using only one valve group.

See Figures 18, 19, and 20 for the wiring diagrams displaying Options 1 through 3.

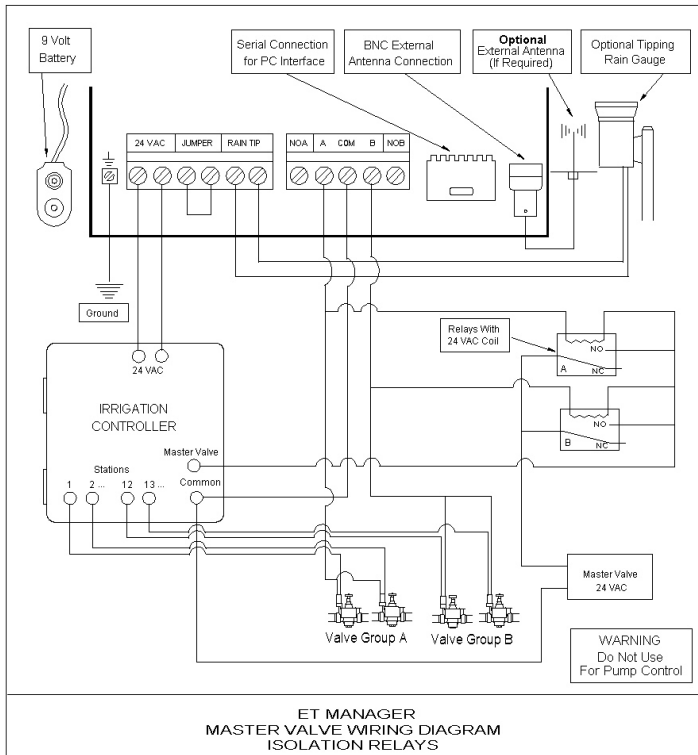

Figure 18. ET Manager Master Valve Wiring Diagram using Isolation Relays

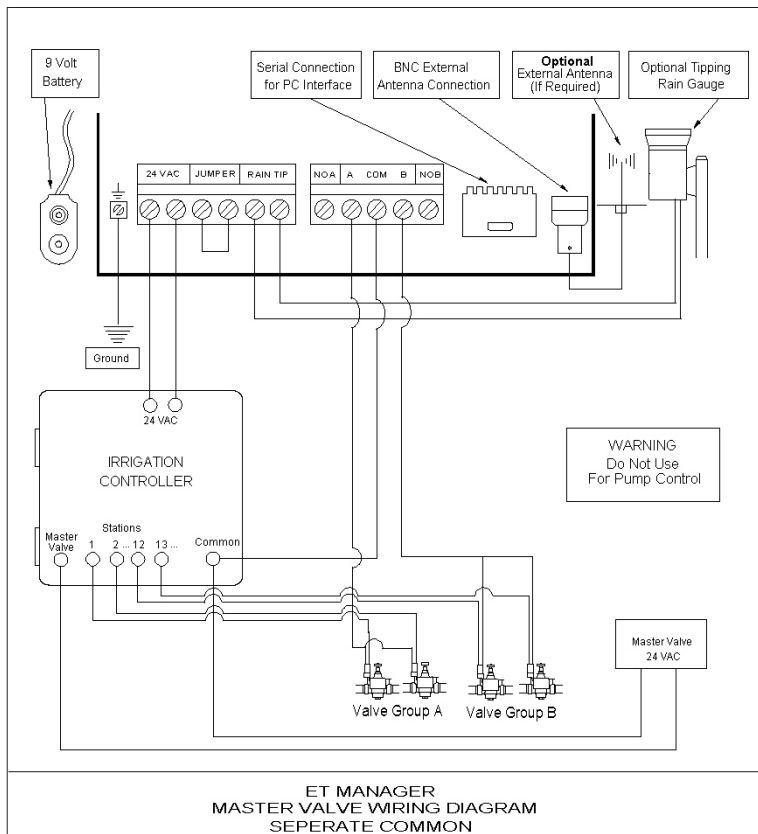

Figure 19. ET Manager Master Valve Wiring Diagram using Separate Common

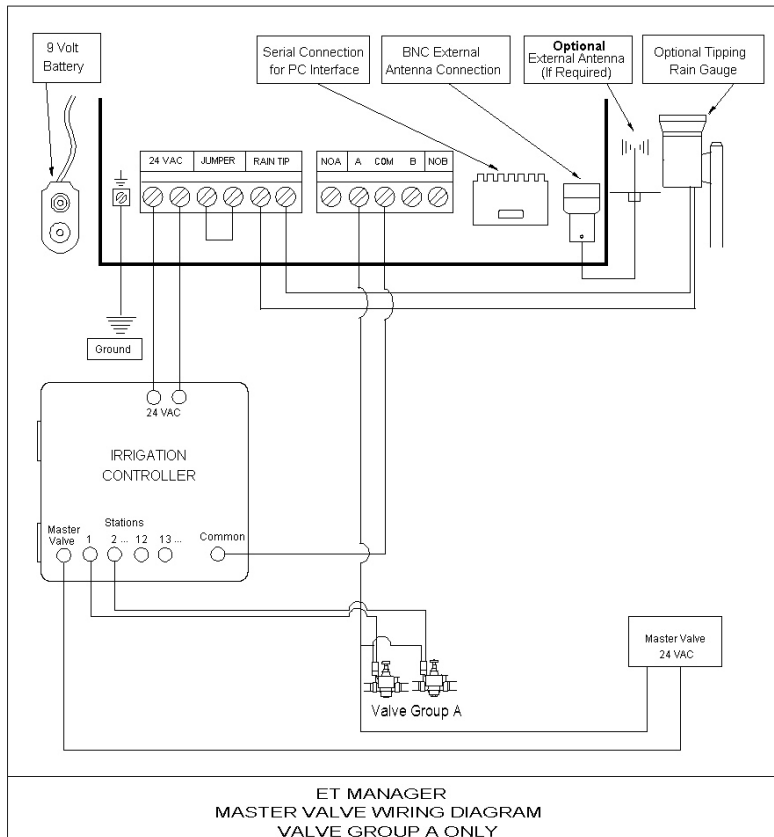

Figure 20. ET Manager Master Valve Wiring Diagram using Valve Group A Only

Pump Control

Pump control can be utilized, but it is limited to working with one Valve Group only.

Pump Control Warning: The ET Manager must **NOT** be used to control a pump when more than one valve group is used. The result will be that the pump turns on without a valve being on.

10. Glossary

Accuracy: The ET Manager looks at the last two weeks of weather signals and reports the accuracy of the weather signal. An accuracy level less than 65% will create an attention condition.

Attention Indicator Light: A yellow light signals a condition that you should be aware of. An attention message is displayed on the Home screen.

Automatic Mode: Automatic mode is the standard Control Mode setting. In this mode all automatic functions are active and your ET Manager will operate as programmed.

Automatic Window: The Automatic Window is programmed to match the first start time programmed in your sprinkler controller, and to stay open until your sprinkler controller has completed watering all cycles. A status message on the Home screen indicates when the Automatic Window is open. Watering is either interrupted or enabled during the Automatic Window. If watering is enabled (Valve Indicator Light(s) is green), a current sensor is used to verify that the sprinkler controller operates during the time period.

Available Watering Days: The days available for watering are programmed in your ET Manager or your sprinkler controller. Typically Available Watering Days are set to “all” or everyday.

Clear Data: The ET Manager stores two weeks of weather signal data. Records can be cleared if needed. Clearing the data will erase all of the stored data. Clearing data will also reset moisture levels to zero. Clearing Data will not change any settings.

Control Mode: Normally your ET Manager should be set to operate in the Automatic mode. Other modes include Disabled and Historical ET. This menu allows you to select the control mode.

Crop Coefficients (Kc): A factor percentage to modify ET_{OS} based on a specific plant type. It is used to adjust an ET value to meet the specific needs of a plant, $ET_{OS} \times K_C = ET_C$. There are both local and seasonal variations in K_C values.

Cursor: The “▶” symbol indicates the current cursor location.

Daily Window: The Daily Window is a period of time programmed in your ET Manager corresponding to the time period the sprinkler controller is programmed to water BUT NOT based on ET control. Watering is allowed every day during the Daily Window. When the Daily Window “opens” it enables or allows watering on both Valve Groups A and B. The Daily Window period operates outside the Automatic Window.

Decoder Failure: Your ET Manager uses signal decoder to receive the weather signal. The Attention Light will come on and “Decoder Failure” will appear if your ET Manager is experiencing decoder problems.

Disabled Mode: The ET Manager can be disabled. This can be selected from the Control Mode menu. When Disabled all automatic functions are suspended. The weather signal will continue to be received and logged, ET will be calculated, while all outputs are disabled and the indicator lights will be off.

Effective Rain Settings: Effective rain is the amount of rain that is an effective or available source of water for the plant. When rainfall amounts and intensities are extreme, not all rainfall will stay within the root zone. To restrict the amount of rain recognized by the system, two effective rainfall limits should be programmed: Max Hourly Rain and Saturation Allowance (see definitions for Max Hourly Rain and Saturation Allowance).

Elevation: Your ET Manager uses elevation above sea level when calculating ET.

Enable: The ET Manager uses this Output Method to control the days a sprinkler controller is allowed to water. It will enable watering when it is needed. This mode bypasses the common output of the controller.

Enable A then B: This Output Method operates the same as the Enable method with one significant difference, where watering is allowed on only one valve group per day. Watering on the other valve group will be delayed until the following day.

ET: An abbreviation for evapotranspiration (see evapotranspiration).

ET and Rain Pulse: An Output Method that delivers ET and rain data to a compatible sprinkler controller. A dry contact switch closure represents 0.01 inches of ET. The rain output signals 0.01 inches of rain with a dry contact switch closure. Compatible sprinkler controllers use this information to make watering scheduling decisions.

ETc: Evapotranspiration calculated to include landscape adjustments and crop coefficients.

ET Manager (Model ETMi): An accessory to a sprinkler controller to automate watering schedules based on real-time weather data ensuring watering occurs only as needed.

ET Manager 120-volt AC Plug-in Transformer 635640 (Model ETMi-TRAN): An optional ET Manager power source is the plug-in transformer and it draws power from a standard 120-volt AC outlet.

ET Manager Outdoor Enclosure (ETMi-OE): ET Manager outdoor enclosure option made of industrial lockable fiberglass, a NEMA 4X cabinet with 110-volt AC outlets.

ET Manager Programming Software (ETM-PS): The ET Manager Programming Software is a software program that simplifies ET Manager programming. The ETM-PS allows you to connect your ET Manager to a personal computer to perform several key functions.

ET Manager Scheduler: The Rain Bird ET Manager Scheduler software program uses site specific information to help you prepare a watering schedule that can be programmed in your sprinkler controller. The ET Manager Scheduler can also be used to help in determining initial settings for your ET Manager.

ET Manager Settings: Your ET Manager operation requires programming specific settings. Most of the programmable settings are site specific.

ETMi: Model number for the ET Manager controller interface, for indoor use only.

ET Manager Remote Antenna Kit (ETMi-ANT): If the weather signal is regularly missed with the built-in antenna, the ET Manager Remote Antenna Kit may be connected and mounted in a location for better reception.

ET Pulse with Weather Interrupt: An Output Method that delivers ET to a compatible sprinkler controller and interrupts watering during high winds, freezing temperatures and rainfall. A dry contact switch closure signal represents 0.01 inches of ET. A second output acts as a sensor interrupt to prevent watering if any one of the three Weather Interrupt conditions occurs. Compatible sprinkler controllers use this information to make watering scheduling decisions.

Evapotranspiration or ET: A measurement of the water that evaporates from the soil and transpires from a plant. ET represents the total moisture loss from the root zone.

Exposure: Environmental exposures, such as sun exposure, high winds, or shade, can increase or decrease the rate of evaporation. Exposure areas that would increase the rate of evaporation may need longer station run times, while exposure areas that would decrease the rate of evaporation may be fine with shorter station run times.

Historical ET: The ET Manager can be set to operate using historical ET data, instead of the weather signal data. If a problem occurs and the ET Manager is not receiving the weather signal, it will continue to operate using historical ET data as a default ET. This setting represents an average daily ET for each month.

10. Glossary

Historical ET Mode: Historical ET mode uses an average daily ET for each month programmed in the ET Manager instead of the weather signal data to operate. In the Historical ET Control Mode information from the weather signal is ignored. If there is an on-site rain gauge, the rain data collected will be used to adjust watering schedules.

Hour Manual Override: Your ET Manager can be temporarily “Overridden” to allow manual watering. Each time the Override is pressed, one more hour is added to the Override mode. The “Hour Manual Override” status message indicates when an Override has been started and the amount of time left before it reverts back to the normal operating mode.

Humidity: Relative humidity is measured at the weather station and is included in the weather signal to calculate ET.

Information Log: Your ET Manager reports important information such as: the last time the sprinklers watered, how many times the sprinklers watered, how much water has been applied, the last weather interrupt and signal accuracy. Find these values in the information log menu.

Irrigation Amount: The amount of water, in inches (or mm) applied to your landscape by each watering cycle(s). This amount of water must evaporate before the ET Manager will allow watering to occur. The Irrigation Amount is based on your soil type and the plant root depth.

Irrigation Status: You can view the details of the current Moisture Levels for Valve Group A and B, Moisture Level graphs, ET, and rainfall information stored over the last two weeks in the Irrigation Status menu.

Landscape Adjustment Percentage: The Landscape Adjustment Percentage is used to adjust for site-specific landscape needs for Valve Group A and Valve Group B. The Landscape Adjustment Percentage is applied to the calculated ET, and effects the current Moisture Levels for Valve Groups A and B.

Last Interrupt: The Last Interrupt displays the cause, date, and time of the last weather interrupt. Weather interrupts occur during irrigation when specific conditions are met. Weather interrupts can be programmed for temperature, wind, or rain conditions.

LCD Display: The graphical display is used to view current operating conditions, monitor status, view settings, and make programming changes.

Look-Ahead Feature: If Available Days have been restricted and not set to “All,” the ET Manager looks ahead each day to determine if watering should occur even though the Moisture Level has not reached zero.

Master Valve Control: Master valve control can be utilized with your ET Manager, refer to Appendix X.

Max Hourly Rain: The Maximum Hourly Rain is the maximum amount of rain that will be accepted each hour in the soil moisture level, see Effective Rain.

Menu Path: Menu paths are found throughout the manual to show which items within the menu and submenus need to be selected to access key information or to adjust settings.

Example of a Menu path: **Main Menu ► Settings ► Irrigation Status ► “A” Moisture Level**

Missing Data: The ET Manager checks and stores data received in the weather signal. If data is missed then ET is calculated using a data replacement formula. If signal reception accuracy is less than 65% then the Missing Data alert will come on due to 35% of missing data.

Moisture Level: Moisture is depleted from the soil due to evaporation. Rain and water from the sprinkler system replaces this water. Your ET Manager computes the current Moisture Levels for Valve Group A and Valve Group B. When the Moisture Level reaches 0, watering is enabled and the sprinkler controller is allowed to water.

Navigation Buttons: The ◀, ▲, ▼, or ▶ navigation buttons are used to position the cursor at the desired location and navigate through the ET Manager menus.

No Historical ET Data: The ET Manager uses a historical ET database as a backup in the event weather signal service is not available. Historical ET data is programmed in your ET Manager based on local conditions. If your ET Manager is not programmed with historical ET data, a No Historical ET Data attention message will appear on the Home screen.

No Paging Signal: The ET Manager periodically verifies the presence of the Paging Signal. If the paging signal is not detected after a period of time the Attention Indicator Light will come on and the No Paging Signal is displayed on the Home screen.

No Power: The ET Manager needs power to operate. The battery is used only to keep time during a power outage and keep the display screen active. If there is no power, the Attention Indicator Light will not come on, but a No Power message will appear on the Home screen.

No Signal Service: Your Weather Reach Signal Provider (WRSP) can send a “No Signal Service” signal to cancel weather signal reception. Typically this would happen only if the terms of the service agreement were not met.

No Water Day: Available watering days can be programmed in your ET Manager. If the current day has been set to “Off,” watering will not be *enabled* regardless of the current Moisture Levels. The No Water Day status message indicates that the current day has been set to “Off.”

No Watering Detected: Your ET Manager may not detect watering if your ET Manager has not been properly wired or the sprinkler controller has not been properly programmed. “No Watering Detected” appears on the Home screen and the Attention Indicator Light turns on when this condition occurs.

No Weather Data: If your ET Manager has not received a weather signal for more than 25 hours the Attention Indicator Light comes on and this message will be displayed on the Home screen.

Output Method: To accommodate a variety of sprinkler controllers, the ET Manager has four output methods: Enable, Enable A then B, ET and Rain Pulse, or ET Pulse with Weather Interrupt. Enable is the most common Output Method used.

Override: The override button temporarily bypasses ET Manager control, allowing valve relays to close and enabling watering regardless of the current ET Manager status. Override watering is adjusted in hourly increments.

Password: Access to the ET Manager setting features can be protected by an optional user defined numeric password (from 1 to 255, or “none”).

Plant Type: It is important to understand what plant types (turf grass types, shrubs, trees, and groundcover) are included in the landscape. These different plant types use water at different rates, requiring different Irrigation Amounts and Landscape Adjustment Percentages.

Precipitation Rate: The rate at which water is applied to the landscape, or the precipitation rate, is measured in inches per hour.

Provider Interrupt: The Weather Reach Signal Provider (WRSP) can send a signal to interrupt watering. This may be necessary during an emergency condition in the community requiring watering to be suspended to limit the demand on the community water system. As a service, your WRSP may also watch weather forecasts and choose to interrupt watering. A Provider Interrupt lasts for 24 hours.

Pump Control: Pump control can be utilized with your ET Manager using one Valve Group only, refer to Appendix X.

Rain Interrupt 24 Hours: Rainfall over the last 24 hours that is at or above the Rain Interrupt 24 Hour setting will cause a Weather Interrupt. The weather interrupt is cancelled once the total rainfall in the last 24 hours drops below the Rain 24 Hour setting.

Rain Interrupt 1 Hour: Rainfall over the last hour that is at or above the Rain Interrupt 1 Hour setting will cause a rain interrupt. The weather interrupt is cancelled once the total rainfall in the last hour drops below the Rain 1 Hour setting.

Rain Region: Like the weather region number, a rain region number represents an area where customers share data. Within an area, one on-site tipping bucket rain gauge is used to share localized rain data among ET Manager customers, allowing for a more accurate representation of local rain. Your Weather Reach Signal Provider (WRSP) broadcasts rain region data.

Rain Source: The rain source is the source of rain data for the ET Manager. Rain data comes from the weather signal, from an optional rain gauge, or from a rain region.

Rain Tip Input Failure: Your ET Manager can use real-time rain data collected from an optional on-site rain gauge. If you are using a rain gauge to collect rain data and “Rain Tip Input Failure” appears on the Home screen, your ET Manager is indicating a problem with the Rain Tip wire terminal, installation, or operation of the on-site rain gauge.

Restore Defaults: If ET Manager’s programmed settings have been saved as default settings, and the current settings are changed, by restoring defaults the original saved default settings are restored. If settings were not saved as defaults, restoring defaults restores the factory default settings.

Root Depth: The soil reservoir capacity is directly related to plant root depth. Deeper roots increase the amount of water available to the plants. To promote a deep healthy root system, best horticultural practices recommend less frequent, deep watering. Use a shovel or soil probe to determine root depth.

Saturation Allowance: The amount of rain it takes to saturate the soil after satisfying the Irrigation Amount before run-off occurs. Unique Saturation Allowance settings can be made for Valve Group A and Valve Group B, and are typically programmed as half the Irrigation Amount.

Save Defaults: The current ET Manager settings can be saved. Once saved, you can restore saved settings if settings have been changed incorrectly by using Restore Defaults.

Serial Number: The serial number of your ET Manager is displayed on the LCD contrast screen and is visible under the terminal cover on the left side of your ET Manager.

Set Signal Provider Code: If the attention message, “Set Signal Provider Code” appears on the Home screen, your ET Manager has been installed, but not programmed with the appropriate Signal Provider Code. The Signal Provider Codes can be accessed from www.rainbird.com/etmanager and the ET Manager Scheduler.

Signal Crop Coefficient (or Signal Kc): Crop coefficients are used to modify ET to meet the specific needs of the landscape. The Weather Reach Signal Provider (WRSP) includes a crop coefficient value in the weather signal. You can decide to “Use” or “Ignore” this adjusted value to adjust ET in the Advanced Settings in Irrigation Control.

Signal Provider Code: Your ET Manager must be programmed to receive information from your specific Weather Reach Signal Provider (WRSP). A Signal Provider Code is unique for your WRSP and is necessary for your ET Manager to receive a weather signal. The code consists of 10 different numbers and these 10 numbers are labeled A-J. The Signal Provider Codes can be accessed from www.rainbird.com and the ET Manager Scheduler program.

Site Assessment: A site assessment should be completed to determine site-specific conditions which affect programmable settings in ET Manager and sprinkler controller.

Slope: When sprinklers apply water faster than the soil can absorb it, water can run-off. Sloping landscapes increase the chance of run-off occurring.

Smart Control: The smart control term is used to designate water efficient systems which operate with your sprinkler system by calculating the evapotranspiration rate, or soil moisture.

Soil: Soil is a habitat for soil organisms and plant roots. It functions as a storehouse for nutrients and a water reservoir. It contains and supplies water, oxygen, nutrients, and provides mechanical support for plant growth.

Sprinkler Controller: A sprinkler controller is an electronic timer that activates automatic sprinkler control valves within a sprinkler system.

Sprinkler System: A sprinkler system delivers water to a landscape and consists of piping, sprinkler valves, sprinkler heads, and a sprinkler controller. Rain and water from the sprinkler system replaces water used in the landscape.

Station: Stations on a sprinkler controller are connected to specific valves that are activated according to your ET Manager. Each station should have plants with similar water requirements within its area. Stations are also referred to as “zones.” Stations must be assigned to specific ET Manager Valve Groups A, B, or none.

Temperature Interrupt: If the hourly weather signal contains air temperatures that reach the Temperature Interrupt setting, watering is interrupted. The weather interrupt is cancelled once the air temperature rises above the programmed interrupt setting received in the hourly weather signal.

Terminal Cover: The terminal cover protects the wire terminal connections on your ET Manager. To access the wire terminals, the terminal cover will have to be removed.

Test Counter: The Test Counter registers every signal received, increasing from 1 to 255 counts. If 255 signals are received and counted, the Test Counter will reset to 0.

Tipping Rain Gauge (Model ETM-RG): A Rain Bird approved, optional on-site tipping rain gauge (1mm/tip) with 30' cable can be connected to the ET Manager. The on-site rainfall value can be used in place of the rainfall value broadcast in the weather signal to provide accurate on-site rain data.

Units: The ET Manager can calculate and display values in either English or Metric units.

Valve Groups A and B: Your ET Manager controls two Valve Groups (A and B) by enabling sprinkler controller output to the valve common. Each valve group must have separate common wires to the valves in the group. For example, lawn valves could be in Valve Group A and shrubs valves in Valve Group B.

Valve Group A & B Indicator Lights: There is one Indicator Light for each valve group, A and B. A green light indicates watering is enabled, allowing the sprinkler controller to activate the valve. A red light indicates watering is suspended or interrupted until watering is needed.

Water Window: The ET Manager Water Windows, the Automatic and Daily Windows, must be synchronized with the watering times set in your sprinkler controller. The Watering Windows will not start a watering cycle but are used by the ET Manager to control watering during that programmed period of time.

Weather Info: You can view detailed weather information and graphs of the current weather conditions. The weather info is stored for fourteen days.

Weather Reach Signal Provider (WRSP): The role of your Weather Reach Signal Provider (WRSP) is to retrieve weather information from local weather stations and send the weather signal to your ET Manager.

Weather Reach Water Management System: The Weather Reach Water Management System automates commercial and residential sprinkler schedules using real-time weather conditions which are sent to your ET Manager via your local Weather Reach Signal Provider (WRSP).

10. Glossary

Weather Region: The weather region number represents a weather station assigned by the Weather Reach Signal Provider (WRSP). The weather region you program in your ET Manager should correspond to a weather station that closely represents the location of the ET Manager. The WRSP assigns each weather station a weather region number.

Weather Signal: A Weather Reach Signal Provider (WRSP) retrieves weather information from local weather stations. The information is broadcast as a weather signal via a paging radio frequency to your ET Manager. The weather signal contains the most recent weather conditions including: solar energy, temperature, wind, humidity, and rainfall.

Wind Adjust: The wind speed measurement included in the weather signal can be scaled by a percentage to compensate for variations in prevailing conditions using the wind adjust setting.

Wind Interrupt: If the hourly weather signal contains wind speeds that reach the Wind Interrupt setting, watering is interrupted. The Weather Interrupt is cancelled once the wind speed decreases below the programmed Wind Interrupt setting.

WRSP: An abbreviation for Weather Reach Signal Provider.

Rain Bird's Professional Customer Satisfaction Policy

Rain Bird will repair or replace at no charge any Rain Bird professional product that fails in normal use within the warranty period stated in the Rain Bird Landscape Irrigation Products Catalog. You must return said product to the dealer or distributor where you bought it. Product failures due to acts of God including without limitation, lightning and flooding, are not covered by this warranty.

This commitment to repair or replace is our sole and total warranty.

Implied warranties of merchantability and fitness, if applicable, are limited to one year from the date of sale.

We will not, under any circumstances be liable for incidental or consequential damages, no matter how they occur.

The ET Manager comes with default settings. These settings can be overridden when a Rain Bird Distributor programs site specific settings. Settings entered by the Rain Bird Distributor are programmed as probable initial settings. Many conditions affect each of the above settings. The Installer, Distributor, Weather Signal Provider or Rain Bird makes no guarantee that these settings or the default settings correctly meet the needs for any specific site. The Owner will need to adjust settings to meet specific site conditions.

The Weather Reach Signal Provider (WRSP) accesses weather data from local weather stations and contracts with a paging service company. The WRSP operates independent of the Installer, Distributor, paging company and Rain Bird. Neither the Installer, neither the paging company, neither Distributor nor Rain Bird are responsible for the weather data transmitted by the WRSP. Weather conditions can vary; the WRSP does not represent the weather signal data to precisely represent actual site conditions. The Owner will need to monitor site conditions and adjust the sprinkler system to meet the water requirements of the landscape. By installing the ET Manager, the Owner agrees to hold all above parties harmless in the event any condition arising from the use of this device causes any damage.



Rain Bird Corporation

6991 E. Southpoint Road
Tucson, AZ, 85706, U.S.A.
Phone: (520) 741-6100
Fax: (520) 741-6522

Technical Service and Support

(800) RAINBIRD (U.S. & Canada only)

Rain Bird Corporation

970 W. Sierra Madre Avenue Azusa, CA,
91702, U.S.A.
Phone: (626) 812-3400
Fax: (626) 812-3411

Specification Hotline

(800) 458-3005 (U.S. & Canada only)

Rain Bird International, Inc.

P.O. Box 37
Glendora, CA 91740-0037, U.S.A.
Phone: (626) 963-9311
Fax: (626) 852-7343

www.rainbird.com

The Intelligent Use of Water™ -- Visit www.rainbird.com to learn about our efforts